

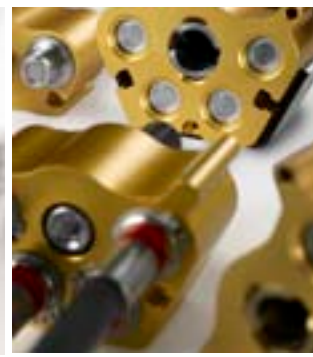

# Hydraulic Products

– For Clean and Leak-free Hydraulic Systems

HYDRAULICS





# The Key to Leadership is our Mindset

*We have maintained our roots in the heart of Sweden throughout our expansion to other markets worldwide. Born and developed through Swedish ingenuity, we have a heritage to be proud of. "Made in Sweden" is, for us, a seal of high industrial quality. Add "by CEJN", and you get the assurance of quality and superior performance.*

## **OUR PRODUCTS**

Our core products are quick connect couplings and nipples for all types of media, from compressed air to gas, breathing air, fluids and hydraulic oil. Regardless of market segment, you can find our products in such diverse fields as agriculture, automotive, construction, off-shore, medical, marine, transportation, wind power and rescue, just to mention a few industries.

## **CEJN - A GLOBAL COMPANY**

Being one step ahead demands being one step closer to the market - a key reason why CEJN has a local presence across the globe. Our local sales offices extend the technical know-how of our hub, offer on-location product support, and on-time deliveries to our customers in all major industrial markets. With over 50 years in business developing, manufacturing and selling products for all types of media to every corner of the world, our products ensure quality and superior performance to guarantee professional use and customer benefit.

**Your Hydraulic Partner!**

We have the experience, the competence, the capacity, the quality and the service. Our high demand on ourselves and on our products speaks for itself. When working with us, you can expect the best from our products and from our staff. Our ambitions demand nothing but the best for our customers!



## Content

<b>FLAT-FACE QUICK CONNECT COUPLINGS</b>	<b>PAGE</b>
X-series Introduction .....	6
X65 - Standard range, meeting and exceeding ISO16028.....	7
X64 - Pressure eliminator nipples.....	10
X62 - Dimensional interchange with ISO16028 .....	12
X66 - Acid proof stainless steel version acc. to ISO16028 .....	13
X-Series - Accessories.....	14
<hr/>	
<b>SCREW-TO-CONNECT COUPLINGS</b>	
TLX Introduction .....	15
TLX Range .....	16
<hr/>	
<b>MULTI-COUPLINGS</b>	
Multi-X Introduction .....	18
Multi-X Range.....	20
<hr/>	
<b>PLUG-IN FITTINGS</b>	
WEO Plug-In Introduction .....	27
WEO Plug-In Range.....	29
<hr/>	
<b>CONVENTIONAL QUICK CONNECT COUPLINGS</b>	
Classic and Nordic Range Introduction .....	37
Classic Range.....	38
Nordic Range .....	39
Nordic Range - Accessories .....	40
<hr/>	
<b>TEST POINT SYSTEMS</b>	
Snap-Check and Press-Check Series Introduction.....	42
Snap-Check Range.....	43
Press-Check Range.....	45

**NOTE!** Not all connections/versions in the catalogue are standard stock items at factory. The local CEJN companies may carry different versions as standard stock items. Check with an authorized CEJN distributor for availability and prices. Some part numbers may be subject to minimum order quantities.



# Clean and Leak-free Hydraulic Systems

*- It's our mission*



## **? WHERE DOES LEAKAGE OCCUR AND WHERE DOES DIRT ENTER HYDRAULIC SYSTEMS?**

"There are two main sources:

Poppet valve-type quick connect couplings

- 5-200 ml (0.17-6.8 oz.) spillage during each disconnection

- Cleanliness is difficult to maintain

- Dust caps are not used or are used incorrectly

Threaded fittings

- Correct torque is difficult to achieve

- Vibrations unscrew the fittings"

## **? BUT IS IT MUCH MORE EXPENSIVE? - I NEED TO BE COMPETITIVE AND MAKE A PROFIT!**

"Yes, in most cases the initial investment to upgrade to a clean and leak-free hydraulic system is a bit more expensive. But the pay-off time is quite short and, on the bottom line, it will improve both your competitiveness and profitability as you will be able to work more effectively, have less down time, a longer life for machinery, quick connect couplings and hoses, less oil consumption etc."



*"Approximately 75% of all hydraulic system failures are related to dirt of some kind"  
(Industrial Technology)*

**? HOW CAN I AVOID CONTAMINATION AND LEAKAGE IN MY HYDRAULIC SYSTEM SO THAT I CAN REDUCE MAINTENANCE COSTS AND DOWN TIME, INCREASE THE SERVICE LIFE OF THE SYSTEM AND PROTECT THE ENVIRONMENT?**

"With its hydraulic range, CEJN has decided to work hard to promote and supply Plug-In fittings and quick connect couplings for clean and leak-free hydraulic systems. The core product ranges in this mission are the X-series, Multi-X, TLX and WEO Plug-In. Although today's advanced hydraulic systems place high demands on cleanliness, outdated ISO-A poppet valve-type couplings are still being used on many modern machines.

Consequently, a high volume of hydraulic oil is spilled every day at disconnections throughout the world resulting in hefty clean-up and replacement oil costs. Subsequently, contaminants can enter the hydraulic system during connection, reducing the service life of the components as well as the overall system.

*For example, a CEJN customer was previously plagued with oil spill and leakage on a 14-ton excavator. Since the poppet valve-type couplings routinely spilled at disconnection, over 200 liters (53 gallons) of replacement oil were needed annually for the machine! By using CEJN Flat-Face quick connect couplings, the customer improved performance and efficiency and by saving the 200 liters of oil he got the pay-off quickly."*



**? SHOULD WE REPLACE ALL OF OUR SCREW FITTINGS WITH WEO PLUG-IN FITTINGS? (OEM)**

"As a general rule, CEJN WEO Plug-In fittings are a problem solver, not an overall replacement for screw fittings. Start by using them in applications in which traditional screw fittings have resulted in specific problems such as leakage because of unscrewing, premature hose failures, assembly problems, etc. As you come to see the important benefits of WEO Plug-In fittings, you will no doubt want to replace more screw fittings with them."





# Flat-Face Quick Connect Couplings

## X-Series

– The high performance ISO16028 flat-face coupling on the market

### THE X-SERIES IS ONE OF THE CORE PRODUCTS IN CEJN'S MISSION TO SUPPLY PRODUCTS FOR CLEAN AND LEAK-FREE HYDRAULIC SYSTEMS

By using our Flat-Face X-series you minimize contamination in your hydraulic system, avoid pollution of the environment as you don't have spillage at disconnection and at the same time you have a coupling with the highest performance on the market to withstand the toughest applications. By using an eliminator nipple from our X64 series you will also make it possible to connect with high residual pressure in the system.

### ? - IT'S AN ISO FLAT-FACE COUPLING, WHAT MAKES CEJN BETTER THAN THE OTHER COUPLINGS AVAILABLE ON THE MARKET?

The CEJN X-series have features that are unique and gives the customer benefits he really can take advantage of.

- The unique design of CEJN's couplings and nipples makes it possible to connect with some residual pressure without damaging anything in the couplings, also with standard products. This is possible on both couplings and nipples as long as you only have residual pressure on one side. The only limitation to connect is your strength. If your strength is not enough the residual pressure is too high and you need an X64 nipple with pressure eliminator which makes it possible to connect with high residual pressure without excessive force. Residual pressure is something that occurs in more or less all applications where quick connect couplings are used.

- One of the biggest benefits you get by choosing CEJN X-series is longer life time, longer endurance in heavy duty applications and a high working pressure. When producing the CEJN nipples we use case hardening of the nipple bodies which gives the highest surface hardness possible. The most common hardening method is local hardening (induction), on specific areas on the nipple, which typically has a surface hardness that is 30% lower than the method CEJN use (see graphics). This is of course a big advantage in the toughest applications but also in more ordinary applications where you will get a longer life time on your quick connect couplings.

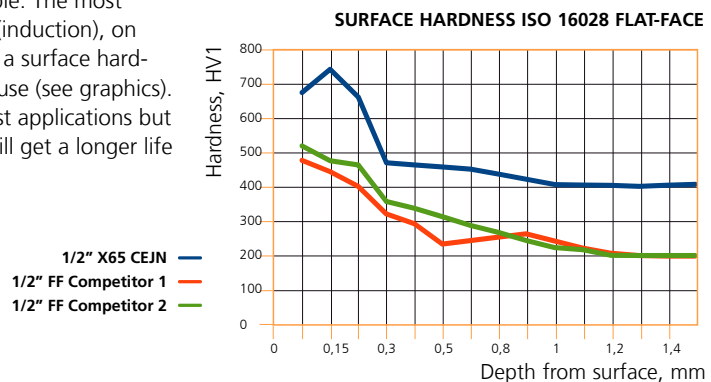

Typical results of surface hardness test comparing CEJN with competitors



QR code for X65 Range

# X65 Range - Premium ISO 16028 Flat-Face Quick Couplings

DN5 (165), DN6.3 (265), DN10 (365), DN 12.5 (565),  
DN16 (665), DN19 (765), DN25 (065)

- Minimize contamination of your hydraulic system
- Spill free disconnection
- High performance
- Connect under residual pressure, only limited by your strength

Temperature range: ..... -30°C – +100°C (-22°F – +212°F)  
 Material seal:..... Nitrile (NBR/PUR, other sealing materials on request)  
 Material: ..... Steel (zinc-nickel, zinc passivation)  
 Connectability: ..... Only limited by operator strength  
 Disconnection under pressure: ..... Not allowed  
 Interchangeable with: ..... All brands dimensionally interchanging with ISO16028



Dia (mm)*	Body Size			Series	Flow rate @ ΔP = 3 Bar		Max. working pressure				Min. burst pressure				Spillage @ Disconnect (ml)
	ISO - DN	Inch	Dash		(l/min)**	(GPM)**	Connected		Disconnected		Connected		Disconnected		
12.0	5	1/8"	-02	165	7.5	2.0	720	10442	720	10442	1800	26106	1800	26106	0.02
16.1	6.3	1/4"	-04	265	24	6.3	500	7251	500	7251	1500	21755	1500	21755	
19.7	10	3/8"	-06	365	44	11.6	400	5801	400	5801	1200	17404	1200	17404	
24.5	12.5	1/2"	-08	565	93	24.6	400	5801	400	5801	1200	17404	1200	17404	
27.0	16	5/8"	-10	665	139	36.7	400	5801	400	5801	1200	17404	1200	17404	
30.0	19	3/4"	-12	765	188	49.7	400	5801	400	5801	1200	17404	1200	17404	
36.0	25	1"	-16	065	330	87.2	350	5076	350	5076	1200	17404	1200	17404	

(\*\*) If the application is constantly above this flow rate for the respective coupling size, a larger coupling size should be considered to avoid too high a pressure drop. The couplings can handle a much higher flow rate but there is a risk of heat build-up in the system. In general, surge flows above the normal flow rate are not a problem. (\*) Diameter for easy identification of ISO16028 Flat-Face coupling size (see picture).

## PRESSURE DROP CHART

Pressure drop ΔP (PSI)

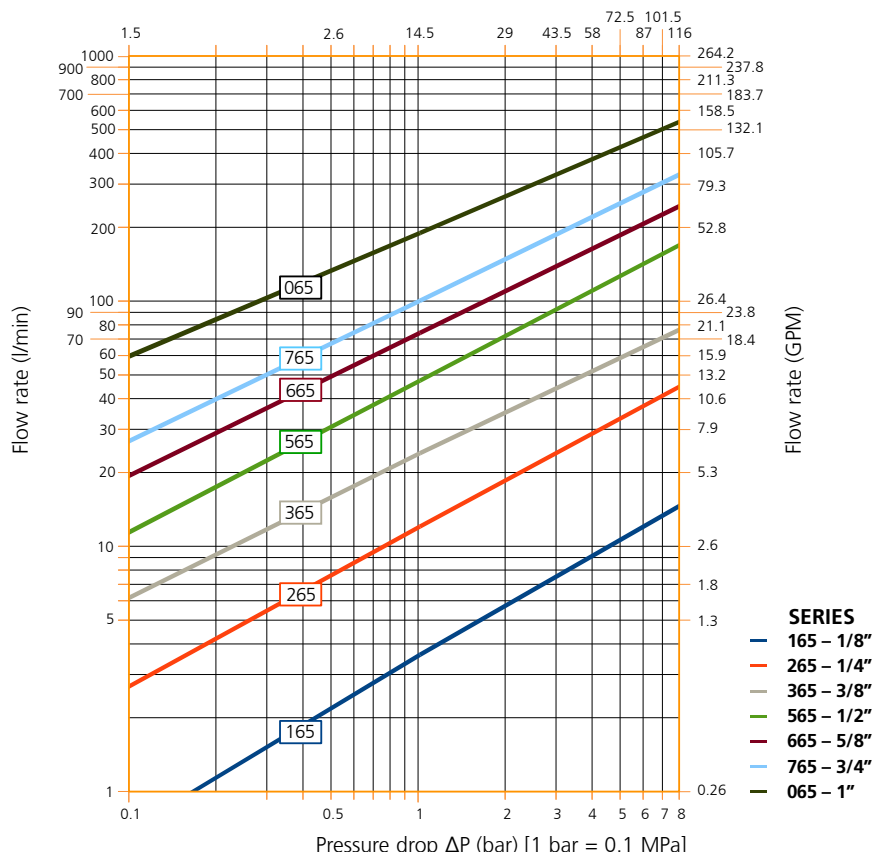

CEJN reserves the right to make changes without further notification. Check with an authorized CEJN distributor for availability and prices. All measurements are in mm. Thread connections are listed according to ISO Standards. Other connections on request. Please visit our website, www.cejn.com, for general maintenance tips.

COUPLINGS & NIPPLES

Body Size			Connection			Part No.		Weight (g)		Package Qty.			
ISO - DN	Inch	Dash	Description	Type	Standards	Coupling/Female	Nipple/Male	Coupling	Nipple				
5	1/8"	-02	G 1/8" (BSP)	Female thread	DIN 3852	10 165 1201	10 165 6201	96	42	10			
6.3	1/4"	-04	Rc 1/4" (BSPT)	Female thread	ISO 7/1	10 265 1102	10 265 6102	143	80				
			G 1/4" (BSP)	Female thread	DIN 3852	10 265 1202	10 265 6202	143	78				
			1/4" NPT	Female thread	ANSI B1.20.3	10 265 1402	10 265 6402	144	79				
			7/16"-20 UNF (1/4" SAE)	Female thread	SAE J 1926-1	10 265 1602	10 265 6602	148	83				
			M14x1.5 08L	Male thread	ISO 8434-1-L	10 265 1554	10 265 6554	147	81				
			M16x1.5 10L	Male thread	ISO 8434-1-L	10 265 1555	10 265 6555	149	83				
10	3/8"	-06	Rc 3/8" (BSPT)	Female thread	ISO 7/1	10 365 1104	10 365 6104	226	120				
			Rc 1/2" (BSPT)	Female thread	ISO 7/1	10 365 1105	10 365 6105	230	122				
			G 3/8" (BSP)	Female thread	DIN 3852	10 365 1204	10 365 6204	218	115				
			G 1/2" (BSP)	Female thread	DIN 3852	10 365 1205	10 365 6205	230	129				
			3/8" NPT	Female thread	ANSI B1.20.3	10 365 1404	10 365 6404	226	117				
			1/2" NPT	Female thread	ANSI B1.20.3	10 365 1405	10 365 6405	230	120				
			9/16"-18 UNF (3/8" SAE)	Female thread	SAE J 1926-1	10 365 1604	10 365 6604	250	139				
			3/4"-16 UNF (1/2" SAE)	Female thread	SAE J 1926-1	10 365 1605	10 365 6605	263	153				
			11/16"-16 ORFS bulkhead	Male thread	SAE J 1453	10 365 1757	10 365 6757	307	197				
			M16x1.5 10L	Male thread	ISO 8434-1-L	10 365 1552	10 365 6552	234	124				
			M18x1.5 12L	Male thread	ISO 8434-1-L	10 365 1554	10 365 6554	235	125				
			M22x1.5 15L	Male thread	ISO 8434-1-L	10 365 1555	10 365 6555	242	132				
			M18x1.5 12LS bulkhead	Male thread	ISO 8434-1-L	10 365 1557	10 365 6557	284	174				
			M22x1.5 15LS bulkhead	Male thread	ISO 8434-1-L	10 365 1558	10 365 6558	329	219				
			G 3/8" JIS ORB	Female thread	JIS B2351	10 365 1294	10 365 6293	244	115				
			G 1/2" JIS ORB	Female thread	JIS B2351	10 365 1295	10 365 6296	253	144				
			12.5	1/2"	-08	Rc 1/2" (BSPT)	Female thread	ISO 7/1	10 565 1105		10 565 6105	396	272
						G 1/2" (BSP)	Female thread	DIN 3852	10 565 1205		10 565 6205	386	250
G 3/4" (BSP)	Female thread	DIN 3852				10 565 1207	10 565 6207	375	238				
1/2" NPT	Female thread	ANSI B1.20.3				10 565 1405	10 565 6405	396	264				
3/4"-16 UNF (1/2" SAE)	Female thread	SAE J 1926-1				10 565 1605	10 565 6605	461	333				
7/8" - 14 UNF (5/8" SAE)	Female thread	SAE J 1926-1				10 565 1606	10 565 6606	469	332				
1 1/16"-12 UN (SAE 3/4")	Female thread	SAE J 1926-1				10 565 1607	10 565 6607	469	270				
13/16"-16 ORFS bulkhead	Male thread	SAE J 1453				10 565 1756	10 565 6756	501	371				
1"-14 ORFS bulkhead	Male thread	SAE J 1453				10 565 1758	10 565 6758	585	451				
M18x1.5 12L	Male thread	ISO 8434-1-L				10 565 1554	10 565 6554	375	244				
M22x1.5 15L	Male thread	ISO 8434-1-L				10 565 1555	10 565 6555	382	252				
M18x1.5 12LS bulkhead	Male thread	ISO 8434-1-L				10 565 1557	10 565 6557	423	293				
M22x1.5 15LS bulkhead	Male thread	ISO 8434-1-L				10 565 1558	10 565 6558	461	332				
G 1/2" JIS ORB	Female thread	JIS B2351				10 565 1295	10 565 6296	410	275				
16	5/8"	-10	Rc 3/4" (BSPT)	Female thread	ISO 7/1	10 665 1101	10 665 6101	468	314				
			G 3/4" (BSP)	Female thread	DIN 3852	10 665 1201	10 665 6201	465	303				
			3/4" NPT	Female thread	ANSI B1.20.3	10 665 1401	10 665 6401	476	312				
			1 1/16"-12 UN (3/4" SAE)	Female thread	SAE J 1926-1	10 665 1601	10 665 6601	500	335				
			M26x1.5 18L	Male thread	ISO 8434-1-L	10 665 1551	10 665 6551	472	312				
			1"-14 ORFS bulkhead	Male thread	SAE J 1453	10 665 1752	10 665 6752	624	464				

CEJN reserves the right to make changes without further notification. Check with an authorized CEJN distributor for availability and prices. All measurements are in mm. Thread connections are listed according to ISO Standards. Other connections on request. Please visit our website, [www.cejn.com](http://www.cejn.com), for general maintenance tips.





**COUPLINGS & NIPPLES**

Body Size			Connection			Part No.		Weight (g)		Package Qty.
ISO - DN	Inch	Dash	Description	Type	Standards	Coupling/Female	Nipple/Male	Coupling	Nipple	
19	3/4"	-12	Rc 1" (BSPT)	Female thread	ISO 7/1	10 765 1103	10 765 6103	751	488	5
			G 3/4" (BSP)	Female thread	DIN 3852	10 765 1201	10 765 6201	766	502	
			G 1" (BSP)	Female thread	DIN 3852	10 765 1203	10 765 6203	714	479	
			3/4" NPT	Female thread	ANSI B1.20.3	10 765 1401	10 765 6401	792	523	
			1" NPT	Female thread	ANSI B1.20.3	10 765 1403	10 765 6403	743	487	
			1 5/16"-12 UN (1" SAE)	Female thread	SAE J 1926-1	10 765 1603	10 765 6603	818	547	
			M26x1.5 18L	Male thread	ISO 8434-1-L	10 765 1551	10 765 6551	718	449	
			M30x2 22L	Male thread	ISO 8434-1-L	10 765 1552	10 765 6552	725	456	
			M26x1.5 18LS bulkhead	Male thread	ISO 8434-1-L	10 765 1555	10 765 6555	837	568	
			M30x2 22LS bulkhead	Male thread	ISO 8434-1-L	10 765 1556	10 765 6556	872	603	
			G 3/4" JIS ORB	Female thread	JIS B2351	10 765 1291	10 765 6291	791	519	
			G 1" JIS ORB	Female thread	JIS B2351	10 765 1292	10 765 6292	754	485	
			Rc 1" (BSPT)	Female thread	ISO 7/1	10 065 1103	10 065 6103	1200	555	
			Rc 1 1/4" (BSPT)	Female thread	ISO 7/1	10 065 1104	10 065 6104	1347	783	
G 1" (BSP)	Female thread	DIN 3852	10 065 1203	10 065 6203	1195	565				
G 1 1/4" (BSP)	Female thread	DIN 3852	10 065 1204	10 065 6204	1297	780				
1" NPT	Female thread	ANSI B1.20.3	10 065 1403	10 065 6403	1200	555				
1 1/4" NPT	Female thread	ANSI B1.20.3	10 065 1404	10 065 6404	1293	747				
1 5/16"-12 UN (1" SAE)	Female thread	SAE J 1926-1	10 065 1603	10 065 6603	1400	560				
G 1" JIS ORB	Female thread	JIS B2351	10 065 1280	10 065 6280	1400	570				
G 1 1/4" JIS ORB	Female thread	JIS B2351	10 065 1281	10 065 6281	1500	760				

**COUPLING FOR PANEL MOUNTING - PUSH-PULL FUNCTION**

Body Size			Connection			Part No.		Weight (g)		Package Qty.
ISO - DN	Inch	Dash	Description	Type	Standards	Coupling/Female	Nipple/Male	Coupling	Nipple	
6.3	1/4"	-04	G 1/4" (BSP)	Female thread	DIN 3852	10 265 1282	-	148		10
10	3/8"	-06	G 3/8" (BSP)	Female thread	DIN 3852	10 365 1284	-	232		
12.5	1/2"	-08	G 1/2" (BSP)	Female thread	DIN 3852	10 565 1285	-	400		
16	5/8"	-10	G 3/4" (BSP)	Female thread	DIN 3852	10 665 1281	-	476		
19	3/4"	-12	G 3/4" (BSP)	Female thread	DIN 3852	10 765 1281	-	784		5

**COUPLINGS/NIPPLES - SPECIAL HIGH PRESSURE VERSION OF 265**

Body Size			Connection			Part No.		Max. working pressure Connected/Disconnected		Min. burst pressure Connected/Disconnected		Package Qty.
ISO - DN	Inch	Dash	Description	Type	Standards	Coupling/Female	Nipple/Male	(bar)	(PSI)	(bar)	(PSI)	
6.3	1/4"	-04	3/8" NPT	Female thread	ANSI B1.20.3	10 265 1434	-	720	10442	1800	26106	10
				Male thread		-	10 265 6484					

This special version is impulse tested at 1.33 x Max. WP for 10,000 pressure cycles.

CEJN reserves the right to make changes without further notification. Check with an authorized CEJN distributor for availability and prices. All measurements are in mm. Thread connections are listed according to ISO Standards. Other connections on request. Please visit our website, [www.cejn.com](http://www.cejn.com), for general maintenance tips.



# X64 Range - ISO 16028 Flat-Face Pressure Eliminator Nipples



QR code for X64 Range

DN6.3 (264), DN10 (364), DN12.5 (564), DN16 (664), DN19 (764), DN25 (064)

- Connection under high residual pressure
- Minimize contamination of your hydraulic system
- Spill free disconnection
- High performance



Temperature range: ..... -30°C – +100°C (-22°F – +212°F)  
 Material seal: ..... Nitrile (NBR/PUR)  
 Material: ..... Steel (zinc-nickel, zinc passivation)  
 Connectability: ..... With static pressure up to 400 bar on the nipple side  
 Disconnection under pressure: ..... Not allowed  
 Interchangeable with: ..... All brands dimensionally interchanging with ISO16028

Dia (mm)*	Body Size			Series	Flow rate @ ΔP = 3 Bar		Max. working pressure				Min. burst pressure				Spillage @ Disconnect (ml)
	ISO - DN	Inch	Dash		(l/min)**	(GPM)**	Connected		Disconnected		Connected		Disconnected		
							(bar)	(PSI)	(bar)	(PSI)	(bar)	(PSI)	(bar)	(PSI)	
16.1	6.3	1/4"	-04	264	20	5.3	500	7251	500	7251	1500	21755	1500	21755	0.02
19.7	10	3/8"	-06	364	44	11.6	400	5801	400	5801	1200	17404	1200	17404	0.03
24.5	12.5	1/2"	-08	564	77	20.3	400	5801	400	5801	1200	17404	1200	17404	0.04
27.0	16	5/8"	-10	664	116	30.6	400	5801	400	5801	1200	17404	1200	17404	0.06
30.0	19	3/4"	-12	764	171	45.2	400	5801	400	5801	1200	17404	1200	17404	0.10
36.0	25	1"	-16	064	290	76.6	350	5076	350	5076	1200	17404	1200	17404	0.11

(\*\*) If the application is constantly above this flow rate for the respective coupling size, a larger coupling size should be considered to avoid too high a pressure drop. The couplings can handle a much higher flow rate but there is a risk of heat build-up in the system. In general, surge flows above the normal flow rate are not a problem. (\*) Diameter for easy identification of ISO16028 Flat-Face coupling size (see picture).

## PRESSURE DROP CHART

Pressure drop ΔP (PSI)

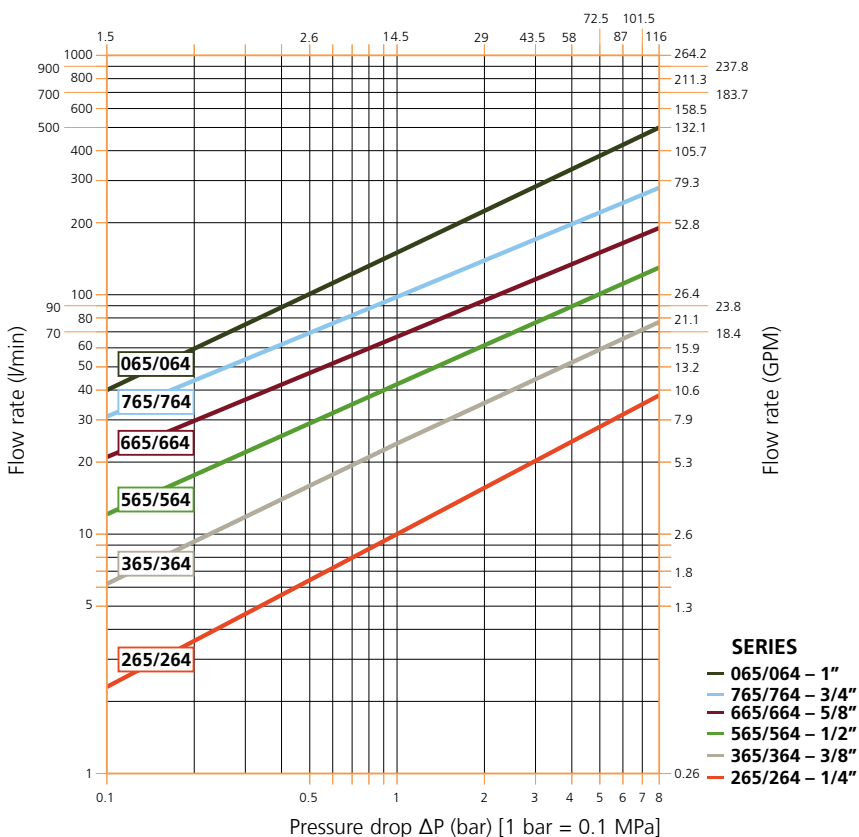

CEJN reserves the right to make changes without further notification. Check with an authorized CEJN distributor for availability and prices. All measurements are in mm. Thread connections are listed according to ISO Standards. Other connections on request. Please visit our website, [www.cejn.com](http://www.cejn.com), for general maintenance tips.

## NIPPLES

ISO - DN	Body Size		Connection			Part No. Nipple/Male	Weight (g)		Package Qty.
	Inch	Dash	Description	Type	Standards		Nipple		
6.3	1/4"	-04	Rc 1/4" (BSPT)	Female thread	ISO 7/1	10 264 6102		144	10
			G 1/4" (BSP)	Female thread	DIN 3852	10 264 6202		140	
			1/4" NPT	Female thread	ANSI B1.20.3	10 264 6402		140	
			7/16"-20 UNF (1/4" SAE)	Female thread	SAE J 1926-1	10 264 6602		154	
			M14x1.5 08L	Male thread	ISO 8434-1-L	10 264 6554		139	
			M16x1.5 10L	Male thread	ISO 8434-1-L	10 264 6555		142	
10	3/8"	-06	Rc 3/8" (BSPT)	Female thread	ISO 7/1	10 364 6104		182	
			Rc 1/2" (BSPT)	Female thread	ISO 7/1	10 364 6105		202	
			G 3/8" (BSP)	Female thread	DIN 3852	10 364 6204		174	
			G 1/2" (BSP)	Female thread	DIN 3852	10 364 6205		186	
			3/8" NPT	Female thread	ANSI B1.20.3	10 364 6404		184	
			1/2" NPT	Female thread	ANSI B1.20.3	10 364 6405		203	
			9/16"-18 UNF (3/8" SAE)	Female thread	SAE J 1926-1	10 364 6604		196	
			3/4"-16 UNF (1/2" SAE)	Female thread	SAE J 1926-1	10 364 6605		207	
			11/16"-16 ORFS bulkhead	Male thread	SAE J 1453	10 364 6757		252	
			M16x1.5 10L	Male thread	ISO 8434-1-L	10 364 6552		181	
			M18x1.5 12L	Male thread	ISO 8434-1-L	10 364 6554		182	
			M22x1.5 15L	Male thread	ISO 8434-1-L	10 364 6555		188	
			M18x1.5 12LS bulkhead	Male thread	ISO 8434-1-L	10 364 6557		231	
			M22x1.5 15LS bulkhead	Male thread	ISO 8434-1-L	10 364 6558		275	
			G 3/8" JIS ORB	Female thread	JIS B2351	10 364 6294		200	
			G 1/2" JIS ORB	Female thread	JIS B2351	10 364 6295		201	
12.5	1/2"	-08	Rc 1/2" (BSPT)	Female thread	ISO 7/1	10 564 6105		368	
			G 1/2" (BSP)	Female thread	DIN 3852	10 564 6205		368	
			G 3/4" (BSP)	Female thread	DIN 3852	10 564 6207		356	
			1/2" NPT	Female thread	ANSI B1.20.3	10 564 6405		373	
			3/4"-16 UNF (1/2" SAE)	Female thread	SAE J 1926-1	10 564 6605		388	
			7/8"-14 UNF (5/8" SAE)	Female thread	SAE J 1926-1	10 564 6606		373	
			1 1/16"-12 UN (3/4" SAE)	Female thread	SAE J 1926-1	10 564 6607		427	
			13/16"-16 ORFS bulkhead	Male thread	SAE J 1453	10 564 6756		475	
			1"-14 ORFS bulkhead	Male thread	SAE J 1453	10 564 6758		557	
			M18x1.5 12L	Male thread	ISO 8434-1-L	10 564 6554		349	
			M22x1.5 15L	Male thread	ISO 8434-1-L	10 564 6555		356	
			M18x1.5 12LS bulkhead	Male thread	ISO 8434-1-L	10 564 6557		398	
			M22x1.5 15LS bulkhead	Male thread	ISO 8434-1-L	10 564 6558		437	
			G 1/2" JIS ORB	Female thread	JIS B2351	10 564 6295		368	
16	5/8"	-10	Rc 3/4" (BSPT)	Female thread	ISO 7/1	10 664 6101		440	
			G 3/4" (BSP)	Female thread	DIN 3852	10 664 6201		438	
			3/4" NPT	Female thread	ANSI B1.20.3	10 664 6401		444	
			7/8"-14 UNF (5/8" SAE)	Female thread	SAE J 1926-1	10 664 6600		477	
			1 1/16"-12 UN (3/4" SAE)	Female thread	SAE J 1926-1	10 664 6601		472	
			M26x1.5 18L	Male thread	ISO 8434-1-L	10 664 6551		444	
			1"-14 ORFS bulkhead	Male thread	SAE J 1453	10 664 6752		597	
19	3/4"	-12	Rc 1" (BSPT)	Female thread	ISO 7/1	10 764 6103		682	
			G 3/4" (BSP)	Female thread	DIN 3852	10 764 6201		732	
			G 1" (BSP)	Female thread	DIN 3852	10 764 6203		678	
			3/4" NPT	Female thread	ANSI B1.20.3	10 764 6401		754	
			1" NPT	Female thread	ANSI B1.20.3	10 764 6403		694	
			1 1/16"-12 UN (3/4" SAE)	Female thread	SAE J 1926-1	10 764 6601		678	
			1 5/16"-12 UN (1" SAE)	Female thread	SAE J 1926-1	10 764 6603		775	
			M26x1.5 18L	Female thread	ISO 8434-1-L	10 764 6551		680	
			M30x2 22L	Female thread	ISO 8434-1-L	10 764 6552		687	
			M26x1.5 18LS bulkhead	Female thread	ISO 8434-1-L	10 764 6555		800	
			M30x2 22LS bulkhead	Male thread	ISO 8434-1-L	10 764 6556		835	
			G 3/4" JIS ORB	Female thread	JIS B2351	10 764 6291		751	
G 1" JIS ORB	Female thread	JIS B2351	10 764 6292		717				
25	1"	-16	Rc 1 1/4" (BSPT)	Female thread	ISO 7/1	10 064 6104		1298	
			G 1" (BSP)	Female thread	DIN 3852	10 064 6203		1200	
			G 1 1/4" (BSP)	Female thread	DIN 3852	10 064 6204		1271	
			1 1/4" NPT	Female thread	ANSI B1.20.3	10 064 6404		1262	
			1 5/16"-12 UN (1" SAE)	Female thread	SAE J 1926-1	10 064 6603		1180	
			G 1" JIS ORB	Female thread	JIS B2351	10 064 6280		1200	
			G 1 1/4" JIS ORB	Female thread	JIS B2351	10 064 6281		1300	

# X62 Range - ISO 16028 Flat-Face Quick Couplings Interchange



QR code for X62 Range

DN 6.3 (262), DN 10 (362), DN 12.5 (562)

- Cost-effective design
- Minimize contamination of your hydraulic system
- Spill free disconnection
- For less stringent demands up to 250 bar

Temperature range: ..... -30°C – +100°C (-22°F – +212°F)  
 Material seal:..... Nitrile (NBR)  
 Material: ..... Steel (zinc passivation)  
 Connectability: ..... Without pressure  
 Disconnection under pressure: ..... Not allowed  
 Interchangeable with: ..... All brands dimensionally interchanging with ISO16028



Dia (mm)*	Body Size			Series	Flow rate @ ΔP = 3 Bar		Max. working pressure				Min. burst pressure				Spillage @ Disconnect (ml)
	ISO - DN	Inch	Dash		(l/min)**	(GPM)**	Connected		Disconnected		Connected		Disconnected		
16.1	6.3	1/4"	-04	262	19	5.0	250	3630	220	3190	1000	14500	880	12760	0.02
19.7	10	3/8"	-06	362	42	11.1	250	3630	220	3190	1000	14500	880	12760	0.03
24.5	12.5	1/2"	-08	562	75	19.8	250	3630	220	3190	1000	14500	880	12760	0.04

## COUPLINGS & NIPPLES

Body Size			Connection			Part No.		Weight (g)		Package Qty.
ISO - DN	Inch	Dash	Description	Type	Standards	Coupling/Female	Nipple/Male	Coupling	Nipple	
6.3	1/4"	-04	G 1/4" (BSP)	Female thread	DIN 3852	10 262 1202	10 262 6202	150	84	10
			1/4" NPT	Female thread	ANSI B1.20.3	10 262 1402	-	150	-	
			3/8" NPT	Female thread	ANSI B1.20.3	-	10 262 6404	-	80	
10	3/8"	-06	G 3/8" (BSP)	Female thread	DIN 3852	10 362 1204	10 362 6204	224	132	
			G 1/2" (BSP)	Female thread	DIN 3852	10 362 1205	10 362 6205	236	128	
			3/8" NPT	Female thread	ANSI B1.20.3	10 362 1404	-	232	-	
			1/2" NPT	Female thread	ANSI B1.20.3	-	10 362 6405	-	120	
12.5	1/2"	-08	G 1/2" (BSP)	Female thread	DIN 3852	10 562 1205	10 562 6205	394	230	
			G 3/4" (BSP)	Female thread	DIN 3852	10 562 1207	10 562 6207	372	234	
			1/2" NPT	Female thread	ANSI B1.20.3	10 562 1405	-	393	-	
			3/4" NPT	Female thread	ANSI B1.20.3	-	10 562 6407	-	226	

## PRESSURE DROP CHART

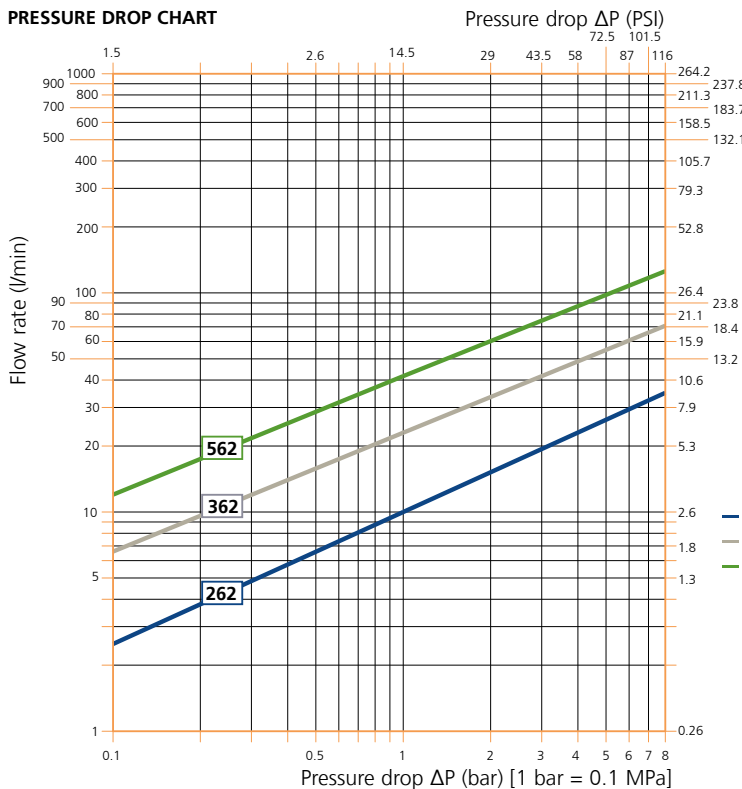

(\*\*) If the application is constantly above this flow rate for the respective coupling size, a larger coupling size should be considered to avoid too high a pressure drop. The couplings can handle a much higher flow rate but there is a risk of heat build-up in the system. In general, surge flows above the normal flow rate are not a problem. (\*) Diameter for easy identification of ISO16028 Flat-Face coupling size (see picture).



**SERIES**  
 — 262 – 1/4"  
 — 362 – 3/8"  
 — 562 – 1/2"

CEJN reserves the right to make changes without further notification. Check with an authorized CEJN distributor for availability and prices. All measurements are in mm. Thread connections are listed according to ISO Standards. Other connections on request. Please visit our website, www.cejn.com, for general maintenance tips.



QR code for X66 Range

# X66 Range - ISO 16028 Flat-Face Stainless Steel

DN 6.3 (266), DN 10 (366), DN 12.5 (566), DN 19 (766)

- All metal components made of AISI 316 stainless steel
- Minimize contamination of your hydraulic system
- Spill free disconnection
- High performance

Temperature range: ..... -20°C – +205°C (-4°F – +401°F)  
 Material seal: ..... Viton (FPM), other sealing materials on request  
 Material: ..... Stainless steel, AISI 316  
 Connectivity: ..... Without pressure  
 Disconnection under pressure: ..... Not allowed  
 Interchangeable with: ..... All brands dimensionally interchanging with ISO16028



Dia (mm)*	Body Size			Series	Flow rate @ ΔP = 3 Bar		Max. working pressure ***				Min. burst pressure				Spillage @ Disconnect (ml)
	ISO - DN	Inch	Dash		(l/min)**	(GPM)**	Connected		Disconnected		Connected		Disconnected		
16.1	6.3	1/4"	-04	266	24	6.3	250	3625	250	3625	1000	14503	1000	14503	0.02
19.7	10	3/8"	-06	366	44	11.6	250	3625	250	3625	1000	14503	1000	14503	0.03
24.5	12.5	1/2"	-08	566	93	24.6	250	3625	250	3625	1000	14503	1000	14503	0.04
30.0	19	3/4"	-12	766	188	49.7	250	3625	250	3625	1000	14503	1000	14503	0.10

## COUPLINGS & NIPPLES

Body Size			Connection			Part No.		Weight (g)		Package Qty.	
ISO - DN	Inch	Dash	Description	Type	Standards	Coupling/Female	Nipple/Male	Coupling	Nipple		
6.3	1/4"	-04	G 1/4" (BSP)	Female thread	DIN 3852	10 266 1212	10 266 6212	160	96	10	
			G 3/8" (BSP)	Female thread	DIN 3852	10 366 1214	10 366 6214	248	141		
10	3/8"	-06	G 1/2" (BSP)	Female thread	DIN 3852	10 366 1215	10 366 6215	263	156		
			3/8" NPT	Female thread	ANSI B1.20.3	10 366 1414	10 366 6414	247	139		
			G 1/2" (BSP)	Female thread	DIN 3852	10 566 1215	10 566 6215	396	268		
12.5	1/2"	-08	G 3/4" (BSP)	Female thread	DIN 3852	10 566 1217	10 566 6217	380	254		
			1/2" NPT	Female thread	ANSI B1.20.3	10 566 1415	10 566 6415	415	280		
			G 3/4" (BSP)	Female thread	DIN 3852	10 766 1211	10 766 6211	748	490		
19	3/4"	-12	G 1" (BSP)	Female thread	DIN 3852	10 766 1213	10 766 6213	748	490		5

## PRESSURE DROP CHART

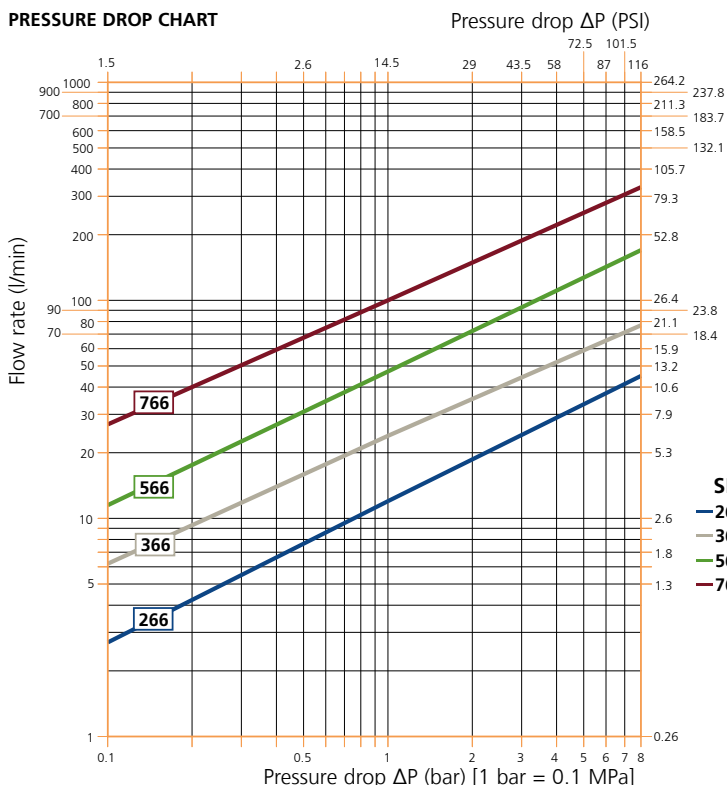

(\*\*) If the application is constantly above this flow rate for the respective coupling size, a larger coupling size should be considered to avoid too high a pressure drop. The couplings can handle a much higher flow rate but there is a risk of heat build-up in the system. In general, surge flows above the normal flow rate are not a problem. (\*) Diameter for easy identification of ISO16028 Flat-Face coupling size (see picture). (\*\*\*) In high impulse applications only 50% of max. working pressure is recommended.

- SERIES**
- 266 - 1/4"
  - 366 - 3/8"
  - 566 - 1/2"
  - 766 - 3/4"



CEJN reserves the right to make changes without further notification. Check with an authorized CEJN distributor for availability and prices. All measurements are in mm. Thread connections are listed according to ISO Standards. Other connections on request. Please visit our website, [www.cejn.com](http://www.cejn.com), for general maintenance tips.

## X-Series – Accessories

- **Dust caps for couplings and nipples**
- **Seal kits for nipples**
- **Fits all X-Series couplings and nipples**

For the X-series we have plastic dust caps, flip dust caps and seal kits available. The dust caps play an important part in prolonging the couplings' life and preventing contamination of your hydraulic system. The seal kits consists of a PUR seal or one O-ring and one backup, depending on the model, for replacement of the front seal in the nipples. The flip dust caps are in general intended for fixed mounted couplings in applications where you want to be sure that the dust cap is on when the coupling is disconnected. Flip dust caps are available in sizes DN10 (3/8") and DN12.5 (1/2").



	Coupling Size			Part No.	Description
	ISO - DN	Inch	Dash		
Seal kits for nipples	6.3	1/4"	-04	10 265 4900	NBR
				10 265 4910	FPM
				10 265 4991	PUR
	10	3/8"	-06	10 365 4900	NBR
				10 365 4910	FPM
				10 365 4991	PUR
	12.5	1/2"	-08	10 565 4900	NBR
				10 565 4910	FPM
				10 565 4991	PUR
	16	5/8"	-10	10 665 4900	NBR
				10 665 4910	FPM
				10 665 4991	PUR
	19	3/4"	-12	10 765 4900	NBR
				10 765 4910	FPM
				10 765 4991	PUR
	25	1"	-16	10 065 4900	NBR
Dust caps	5	1/8"	-02	09 165 1000	For couplings
				09 165 1050	For nipples
	6.3	1/4"	-04	09 265 1000	For couplings
				09 265 1050	For nipples
	10	3/8"	-06	09 365 1000	For couplings
				09 365 1050	For nipples
	12.5	1/2"	-08	09 565 1000	For couplings
				09 565 1050	For nipples
	16	5/8"	-10	09 665 1000	For couplings
				09 665 1050	For nipples
	19	3/4"	-12	09 765 1000	For couplings
				09 765 1050	For nipples
	25	1"	-16	09 065 1000	For couplings
				09 065 1050	For nipples
Flip Dust Cap	10	3/8"	-06	10 365 1010	For couplings
	12.5	1/2"	-08	10 565 1010	

CEJN reserves the right to make changes without further notification. Thread connections are listed according to ISO Standards. All measurements are in mm. Check with an authorized CEJN distributor for availability and prices. Please visit our website, [www.cejn.com](http://www.cejn.com), for general maintenance tips.





# Screw-to-connect Couplings

## TLX Range

*-The coupling that will stand when the others fall*

### **THE MOST COMMON REASON FOR FAILURE OF SCREW-TO-CONNECT COUPLINGS IN HEAVY DUTY APPLICATIONS IS HIGH SURGE FLOWS**

For example, when using a crusher on concrete you will build up high pressure just before you bite through the concrete and, at the moment the crusher bites through the concrete, you will briefly get an extreme surge flow. This surge flow can be several times higher than the ordinary flow rate in the machine and is the cause of many coupling failures. The solution so far has been to use bulky oversized couplings at much higher cost. The new solution is called TLX.

The CEJN TLX has its roots in a patented design with verified performance over many years in industrial auto-couplings which are connected at full working pressure on both sides and used in tough impulse applications. The design of the TLX valve package is highly robust and the seals are protected from being flushed away by surge flow. TLX is designed with a high pitch, high strength round thread profile but without sensitive eliminators or complicated locking systems.

### **TLX IS A FLAT-FACE TWIST LOCK COUPLING MADE OF HIGH ALLOY STEEL AND CRITICAL COMPONENTS ARE HARDENED FOR MAXIMUM PERFORMANCE**

The surface treatment is Zinc-Nickel which is by far the best surface treatment of steel available. The TLX is a spill free coupling and fully in line with CEJN's ambition to supply products for clean and leak-free hydraulic systems.

The flow rate of the TLX is not limited to a certain level as it can handle really high flow without failures. The limitation is on the part of the machine as you don't want to get too high a pressure drop as this will lead to heat build-up in the hydraulic system. If you choose the appropriate size TLX for the flow rate the pump generates, the TLX will also handle the surge flow that can occur in certain applications.



QR code for TLX Range

# Screw-to-connect Couplings

3/4" (607), 1" (707), 1 1/4" (807)



- The Super-Duty connector with extremely high resilience to surge flows
- The Super-Duty connector that handles the pressure impulses
- The Super-Duty connector with pure and simple robustness
- Designated for the toughest construction and demolition applications

**Temperature range:** ..... -30°C – +100°C (-22°F – +212°F)  
**Material seal:**..... Nitrile (NBR), HNBR for high temperature use on request  
**Material:** ..... High alloy steels with Zinc-Nickel surface  
**Connectability:** ..... Connection with residual pressure only limited by operator strength  
**Disconnection under pressure:** ..... Disconnection with residual pressure in the system is allowed

Body Size		Flow rate ΔP = 3 Bar		Max. working pressure				Min. burst pressure			
Inch	Dash	(l/min)**	(GPM)**	Connected		Disconnected		Connected		Disconnected	
				(bar)	(PSI)	(bar)	(PSI)	(bar)	(PSI)	(bar)	(PSI)
3/4"	-12	160	35.2	420	6091	400	5801	1680	24366	1000	14503
1"	-16	285	62.7	420	6091	400	5801	1680	24366	1000	14503
1 1/4"	-20	400	88.0	420	6091	400	5801	1680	24366	1000	14503

(\*\*) If the application is constantly above this flow rate for the respective coupling size, a larger coupling size should be considered to avoid too high a pressure drop. The couplings can handle a much higher flow rate but there is a risk of heat build-up in the system. In general, surge flows far above the normal flow rate are not a problem.

## PRESSURE DROP CHART

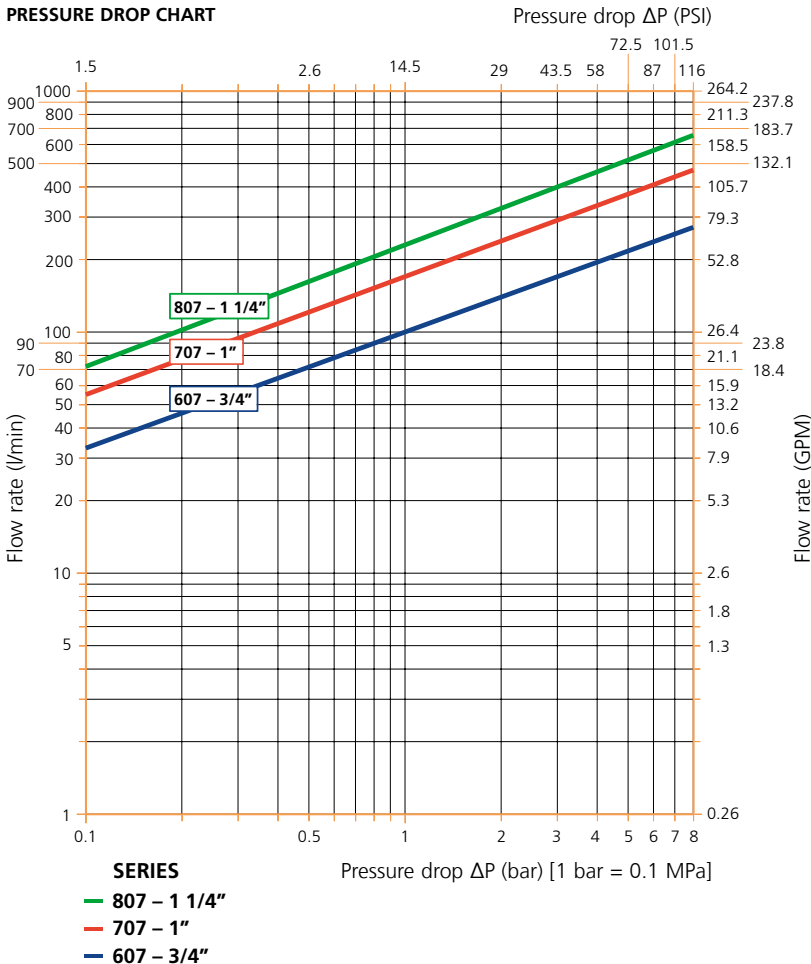



**COUPLINGS & NIPPLES**

Body Size		Connection			Part No.		Dimension locking sleeve Hex		Weight			
Inch	Dash	Description	Type	Standards	Coupling/Female	Nipple/Male	(mm)	(Inch)	Coupling		Nipple	
									(kg)	(lb)	(kg)	(lb)
3/4"	-12	Rc 3/4"	Female thread	ISO 7/1	10 607 1101	10 607 6101	55	2.17	1.073	2.4	1.188	2.6
		G 3/4"	Female thread	DIN3852	10 607 1301	10 607 6301			0.989	2.2	1.105	2.4
		G 1"	Female thread		10 607 1203	10 607 6203			1.029	2.3	1.145	2.5
		G 3/4" JIS ORB	Female thread	JIS B2351	10 607 1231	10 607 6231			1.066	2.4	1.182	2.6
		3/4" NPT	Female thread	ANSI B1.20.3	10 607 1401	10 607 6401			1.079	2.4	1.195	2.6
		1 1/16"-12 UN (3/4" SAE)	Female thread	SAE J 1926-1	10 607 1601	10 607 6601			1.066	2.4	1.182	2.6
1"	-16	Rc 1"	Female thread	ISO 7/1	10 707 1103	10 707 6103	65	2.56	1.892	4.2	2.067	4.6
		G 1"	Female thread	DIN3852	10 707 1203	10 707 6203			1.644	3.6	1.819	4.0
		G 1 1/4"	Female thread		10 707 1204	10 707 6204			1.788	3.9	1.964	4.3
		G 1" JIS ORB	Female thread	JIS B2351	10 707 1233	10 707 6233			1.891	4.2	2.064	4.6
		1" NPT	Female thread	ANSI B1.20.3	10 707 1403	10 707 6403			1.899	4.2	2.074	4.6
		1 5/16"-12 UN (1" SAE)	Female thread	SAE J 1926-1	10 707 1603	10 707 6603			1.883	4.2	2.059	4.5
1 1/4"	-20	Rc 1 1/4"	Female thread	ISO 7/1	10 807 1104	10 807 6104	75	2.95	3.044	6.7	3.631	8.0
		G 1 1/4"	Female thread	DIN3852	10 807 1204	10 807 6204			2.843	6.3	3.168	7.0
		G 1 1/2"	Female thread		10 807 1205	10 807 6205			2.959	6.5	3.540	7.8
		G 1 1/4" JIS ORB	Female thread	JIS B2351	10 807 1234	10 807 6234			3.032	6.7	3.649	8.0
		1 1/4" NPT	Female thread	ANSI B1.20.3	10 807 1404	10 807 6404			3.052	6.7	3.640	8.0
		1 5/8"-12 UN - (1 1/4" SAE)	Female thread	SAE J 1926-1	10 807 1604	10 807 6604			3.030	6.7	3.619	8.0

**Mounting Bracket - Weldable**



Coupling Size		Description	Part No.
Inch	Dash		
3/4"	-12	Mounting bracket for TLX	10 607 4960
1"	-16		10 707 4970
1 1/4"	-16		10 807 4980

**Dust Caps - Plastic with wire harness**



Coupling Size		Description	Part No.	
Inch	Dash		Coupling/Female	Nipple/Male
3/4"	-12	Dust cap	10 607 1000	10 607 1050
1"	-16		10 707 1000	10 707 1050
1 1/4"	-20		10 807 1000	10 807 1050

**Monkey Wrench - Accessory for simple connection that fits all sizes of TLX**



Coupling Size		Description	Part No.
Inch	Dash		
3/4"	-12	Monkey Wrench	10 807 4999
1"	-16		
1 1/4"	-20		



CEJN reserves the right to make changes without further notification. Check with an authorized CEJN distributor for availability and prices. The local CEJN companies may carry different versions as standard stock items. All G-thread connection (BSP) TLX couplings and nipples above are stock standard items at factory. The other thread versions are produced on order and the typical lead time is two weeks from factory. Please visit our website, [www.cejn.com](http://www.cejn.com), for general maintenance tips.



# Multi-Couplings

## Multi-X Range

– Advanced technology made easy and user friendly

### CLEAN AND LEAK-FREE MULTI-CONNECTIONS IN ONE STEP WITH MULTI-X

CEJN Multi-X is a range of innovative, easy to handle, multi-plates designed to meet and exceed the demands of even the most challenging mobile hydraulic applications. Its innovative design rivals and surpasses other existing multi-plates on the market. The unique design made with the user in mind offers you a plate system that provides great flexibility, high performance, easy installation and trouble-free operation.

Multi-X is fully in line with CEJN's objective to supply the market with products that result in clean and leak-free hydraulic systems. The WE0 Plug-in fitting is a leak-free connection with many other benefits and the spill-free flat-face multi-connection assures prevention of spillage and leakage at the same time as it minimizes the risk of contamination of the hydraulic system. Contamination is one of the most common reasons for failures in hydraulic systems.

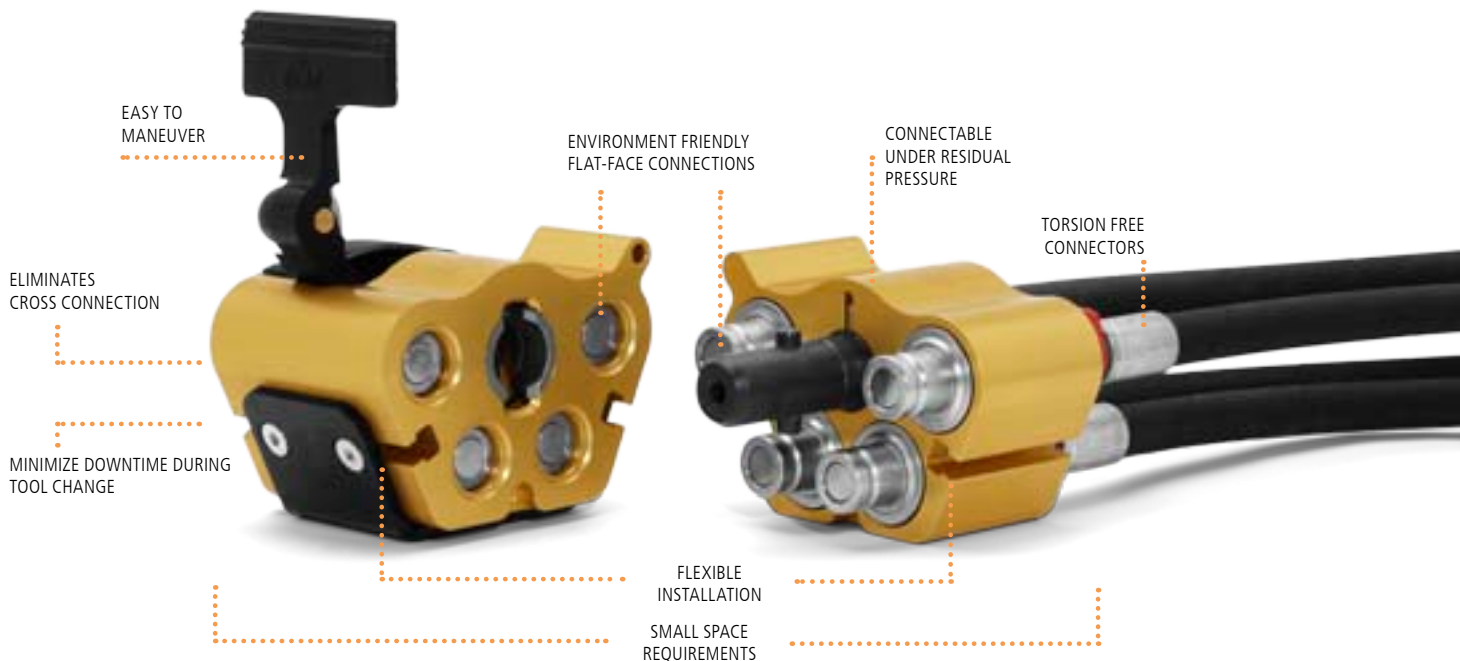



The WEO hose connection is self-aligning and makes connection easy and prolongs hose life.



Working pressure of up to 350 bar (5076 PSI) can be used on half the ports simultaneously with the other half of the ports used as return lines with a maximum pressure of 50 bar (725 PSI)



Single ISO 16028 Flat-Face couplings can be used with fixed installed male plates.



Both the female and male plate can be used as the fixed part.



Electric connectors can easily be attached to each plate.

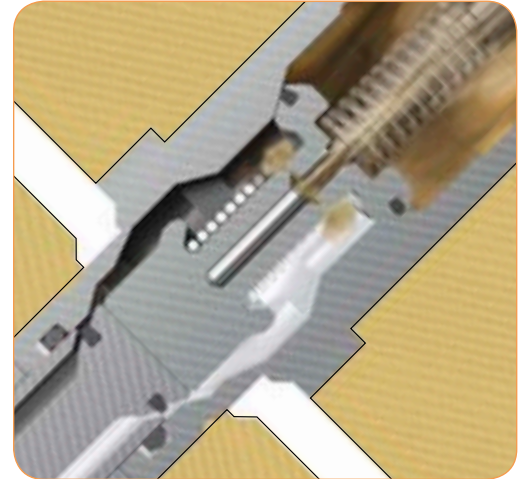

The pressure is punctured without spillage making it simple to connect with residual pressure in the system.

## FLEXIBILITY

Multi-X is available in a number of standard configurations, matching the most frequent application needs. The sizes range from DN 10 to DN 19 combined with two, four or six ports in each plate. Each plate can also be equipped with an optional electric connector (available as accessory).

The innovative design allows you to use either part of the plate system mounted as the fixed part without compromising the performance. The mounting bracket is enclosed with the female plate but you can just as easily use it to install the male plate in the application instead.

An extra advantage when you use the male plate as the fixed part is that you can connect standard ISO 16028 Flat-Face couplings to the Multi-X plate, giving you maximum flexibility to use tools and attachments both with and without a Multi-X plate.

## PERFORMANCE

The Multi-X design allows you to use a working pressure up to 350 bar (5076 PSI) on half the ports simultaneously and the rest of the ports as return lines with a maximum of 50 bar (725 PSI), regardless of whether you use two, four or six ports. The design also offers the possibility to connect the units with residual pressure. (See connectability chart on next page)

## CONNECTIONS

The Multi-X range is outfitted with WEO Plug-In fittings, making them both easy to assemble and to connect. Using Plug-In fittings provides the Multi-X range with the same outstanding features as the CEJN WEO Range products – self-aligning hose connections that prolong hose life, minimize downtimes when the need to replace or remove the hose occurs and its minimal space requirements that allow for more compact designs.

Each Multi-X plate comes with integrated WEO cartridges for easy installation. Use the WEO Hose connection nipples and ferrules to crimp the nipples directly onto the hose or convert your existing hose to WEO Plug-In with the threaded WEO Nipples.

## OPERATION

Multi-X is easily operated with one hand on the lever and one hand guiding the moving plate during both connection and disconnection. The ergonomic lever placed perpendicular to the hydraulic lines keeps the operator's hands safe. The locking button secures the lever when connected and prevents unintentional disconnection.

All Multi-X male plates are equipped with pressure eliminator nipples to make it possible to connect the plates with residual pressure in the system. By puncturing the pressure, without spillage, it allows for a smooth connection even at a high residual pressure (up to 350 bar) (5076 PSI).

The self-aligning WEO connection removes the torsion in the hose, a common issue when using ordinary fittings, making it easy to align and connect the plates.

# Multi-X Range



QR code for Multi-Couplings

- Compact design
- Great flexibility and high performance
- Easy and ergonomic to maneuver - perpendicular lever movement
- Connect with residual pressure



Max working pressure:..... 350 bar (5076 PSI)  
 Min. burst pressure:..... 1200 bar (17405 PSI)  
 Temperature range: ..... -30°C – +100°C (-22°F – +212°F)  
 Material female plate:..... Zinc plated steel, anodized aluminum, zinc, brass  
 Material male plate: ..... Zinc plated steel, anodized aluminum, brass  
 Material seal:..... NBR/PUR  
 Disconnection under pressure: ..... To be avoided. Residual pressure can result in recoil effect during disconnection. Always grip the lever firmly.  
 Comment: ..... Contact CEJN representatives for recommendations for high impulse applications.

Connectability case No.	DN10 - 3/8"	DN12.5 - 1/2"	DN19 - 3/4"
1. Connectable with residual pressure on the male side and free to drain on the female side.	350 bar (5076 PSI)	350 bar (5076 PSI)	350 bar (5076 PSI)
2. Connectable with residual pressure on the female side and free to drain on the male side.	250 bar (3626 PSI)	150 bar (2175 PSI)	60 bar (870 PSI)
3. Connectable with residual pressure on the male side and 10 bar return pressure on the female side	250 bar (3626 PSI)	220 bar (3626 PSI)	220 bar (3191 PSI)

## PRESSURE DROP CHART

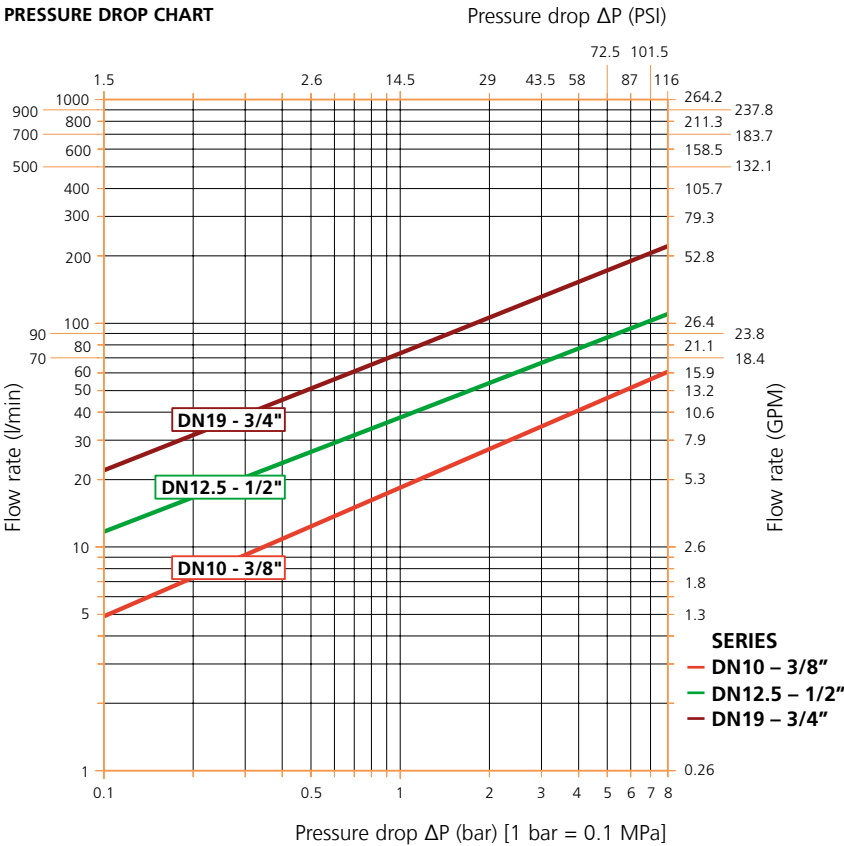

## FEMALE PLATE

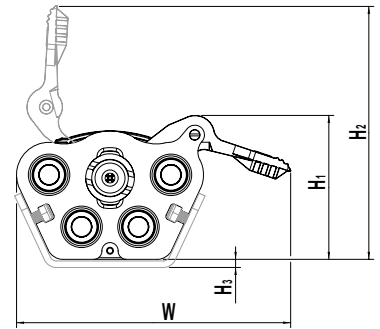
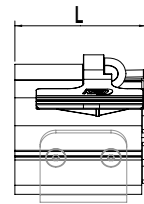

## MALE PLATE

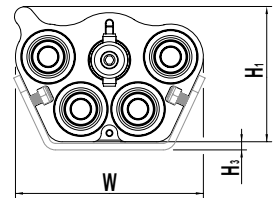
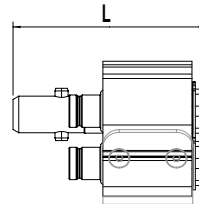

CEJN reserves the right to make changes without further notification. Check with an authorized CEJN distributor for availability and prices. All measurements are in mm. Please visit our website, [www.cejn.com](http://www.cejn.com), for general maintenance tips.

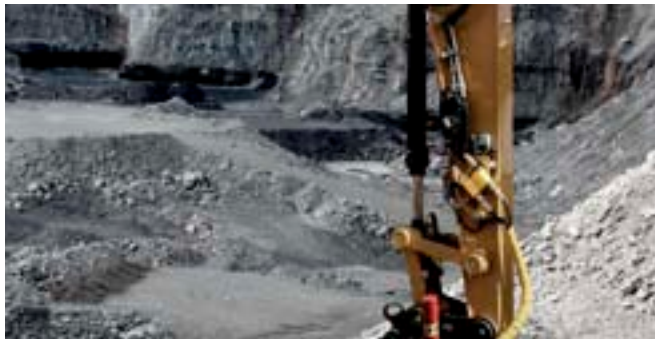



## Multi-X Duo

Coupling Size			No. of lines	Connection		Part No.		Dim. Female plate					Dim. Male plate				
ISO - DN	Inch	Dash		Female plate	Male plate	Female plate	Male plate	L	W	H1	H2	H3	L	W	H1	H2	H3
10	3/8"	-06	2	WEO 1/2"	WEO 3/8"	10 932 2000	10 932 2050	83	168	70	138	5	116	116	66	-	5
				G 3/8" (BSP)	G 3/8" (BSP)	10 932 2200	10 932 2250	83	168	70	138	5	116	116	66	-	5
12.5	1/2"	-08		WEO 3/4"	WEO 1/2"	10 932 2001	10 932 2051	98	176	79	139	5	138	132	73	-	5
				G 1/2" (BSP)	G 1/2" (BSP)	10 932 2201	10 932 2251	98	176	79	139	5	138	132	73	-	5
19	3/4"	-12		WEO 3/4"	WEO 3/4"	10 932 5002	10 932 5052	120	214	107	170	5	182	179	97	-	5
				G 3/4" (BSP)	G 3/4" (BSP)	10 932 5202	10 932 5252	120	214	107	170	5	182	179	97	-	5



## Multi-X Quattro

Coupling Size			No. of lines	Connection		Part No.		Dim. Female plate					Dim. Male plate					
ISO - DN	Inch	Dash		Female plate	Male plate	Female plate	Male plate	L	W	H1	H2	H3	L	W	H1	H2	H3	
10	3/8"	-06	4	WEO 1/2"	WEO 3/8"	10 932 3000	10 932 3050	83	168	88	155	5	116	116	83	-	5	
				G 3/8" (BSP)	G 3/8" (BSP)	10 932 3200	10 932 3250	83	168	88	155	5	116	116	83	-	5	
10+12.5	3/8"+1/2"	-06/-08		2+2	WEO 1/2"+3/4"	WEO 3/8"+1/2"	10 932 4000	10 932 4050	98	176	99	159	5	138	132	93	-	5
				G 3/8"+G 1/2" (BSP)	G 3/8"+G 1/2" (BSP)	10 932 4200	10 932 4250	98	176	99	159	5	138	132	93	-	5	
12.5	1/2"	-08	4	WEO 3/4"	WEO 1/2"	10 932 4001	10 932 4051	98	176	99	159	5	138	132	93	-	5	
				G 1/2" (BSP)	G 1/2" (BSP)	10 932 4201	10 932 4251	98	176	99	159	5	138	132	93	-	5	
12.5+19	1/2"+3/4"	-08+-12	2+2	WEO 3/4"	WEO 1/2"+3/4"	10 932 5000	10 932 5050	120	214	107	170	5	182	179	97	-	5	
				G 1/2"+G 3/4" (BSP)	G 1/2"+G 3/4" (BSP)	10 932 5200	10 932 5250	120	214	107	170	5	182	179	97	-	5	



## Multi-X Hexa

Coupling Size			No. of lines	Connection		Part No.		Dim. Female plate					Dim. Male plate				
ISO - DN	Inch	Dash		Female plate	Male plate	Female plate	Male plate	L	W	H1	H2	H3	L	W	H1	H2	H3
10	3/8"	-06	6	WEO 1/2"	WEO 3/8"	10 932 5006	10 932 5056	120	214	107	170	5	182	179	97	-	5
				G 3/8" (BSP)	G 3/8" (BSP)	10 932 5206	10 932 5256	120	214	107	170	5	182	179	97	-	5

CEJN reserves the right to make changes without further notification. Check with an authorized CEJN distributor for availability and prices. All measurements are in mm. Please visit our website, [www.cejn.com](http://www.cejn.com), for general maintenance tips.



# Multi-X Accessories



QR code for Multi-Couplings

## Multi-X Electric Connector Kits

Multi-X can be fitted with an electric connector kit on both the male and the female plate. The kits contain all necessary components as well as assembly instructions and dust caps.



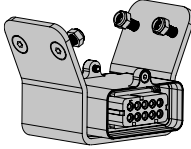
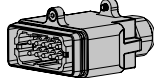

**Connections**..... 10 + ground  
**Voltage**..... 48 V  
**Current**..... 16 A

	Suitable for	Part No.	L	W	H1	H2	H3
Electric connector for female plate 	Multi-X Duo 10	10 932 0010	83	168	101	169	5
	Multi-X Duo 12.5	10 932 0011	98	176	110	170	5
	Multi-X Quattro 10	10 932 0012	83	168	119	186	5
	Multi-X Quattro 10/12.5 Multi-X Quattro 12.5	10 932 0013	98	176	130	190	5
	Multi-X Quattro 12.5/19 Multi-X Duo 19	10 932 0015	120	214	138	201	5
	Multi-X Hexa 10	10 932 0016	83	214	138	201	5
Electric connector for male plate 	Multi-X Duo 10	10 932 0050	116	116	97	-	5
	Multi-X Quattro 10	10 932 0052	116	116	114	-	5
	Multi-X Duo 12.5	10 932 0051	138	132	104	-	5
	Multi-X Quattro 10/12.5 Multi-X Quattro 12.5	10 932 0053	138	132	124	-	5
	Multi-X Quattro 12.5/19 Multi-X Duo 19	10 932 0055	182	179	128	-	5
	Multi-X Hexa 10	10 932 0056	116	179	128	-	5

## Multi-X Aluminum Cover/Parking Dock

The aluminum covers can be used as heavy duty protection when the plates are disconnected. The covers can also easily be mounted and used as fixed parking docks. Covers are only available for plates without electric connectors (can be used with the electric connector but will not cover the electric pins).

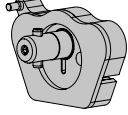
**Material** ..... Aluminum

	Suitable for	Part No.
Aluminum Cover/Parking Dock for Female Plate 	Multi-X Duo 10	10 932 1020
	Multi-X Duo 12.5	10 932 1021
	Multi-X Quattro 10	10 932 1022
	Multi-X Quattro 10/12.5 Multi-X Quattro 12.5	10 932 1023
	Multi-X Quattro 12.5/19 Multi-X Duo 19	10 932 1025
	Multi-X Hexa 10	10 932 1026
Aluminum Cover/Parking Dock for Male Plate 	Multi-X Duo 10	10 932 1070
	Multi-X Duo 12.5	10 932 1071
	Multi-X Quattro 10	10 932 1072
	Multi-X Quattro 10/12.5	10 932 1073
	Multi-X Quattro 12.5	10 932 1074
	Multi-X Quattro 12.5/19 Multi-X Duo 19	10 932 1075
Multi-X Hexa 10	10 932 1076	

CEJN reserves the right to make changes without further notification. Check with an authorized CEJN distributor for availability and prices. All measurements are in mm. Please visit our website, [www.cejn.com](http://www.cejn.com), for general maintenance tips.

# Multi-X Spare Parts



QR code for Multi-Couplings

## Multi-X Dust Caps

The plastic dust caps are enclosed with each plate, but can also be purchased separately.

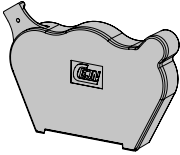
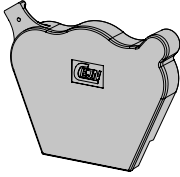
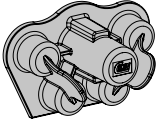
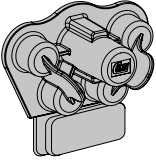

**Material** ..... Soft PVC

	Suitable for	Part No.
Dust caps for Female plate 	Multi-X Duo 10	09 932 1000
	Multi-X Quattro 10	09 932 1001
	Multi-X Duo 12.5	09 932 1002
	Multi-X Quattro 10/12.5 Multi-X Quattro 12.5	09 932 1003
	Multi-X Quattro 12.5/19 Multi-X Duo 19	09 932 1005
	Multi-X Hexa 10	09 932 1006
Dust caps for Female plate with electric connector 	Multi-X Duo 10	09 932 1010
	Multi-X Duo 12.5	09 932 1012
	Multi-X Quattro 10	09 932 1011
	Multi-X Quattro 10/12.5 Multi-X Quattro 12.5	09 932 1013
	Multi-X Quattro 12.5/19 Multi-X Duo 19	09 932 1015
	Multi-X Hexa 10	09 932 1016
Dust caps for Male plate 	Multi-X Duo 10	09 932 1050
	Multi-X Quattro 10	09 932 1051
	Multi-X Duo 12.5	09 932 1052
	Multi-X Quattro 10/12.5 Multi-X Quattro 12.5	09 932 1053
	Multi-X Quattro 12.5/19 Multi-X Duo 19	09 932 1055
	Multi-X Hexa 10	09 932 1056
Dust caps for Male plate with electric connector 	Multi-X Duo 10	09 932 1060
	Multi-X Quattro 10	09 932 1061
	Multi-X Duo 12.5	09 932 1062
	Multi-X Quattro 10/12.5 Multi-X Quattro 12.5	09 932 1063
	Multi-X Quattro 12.5/19	09 932 1065
	Multi-X Hexa 10	09 932 1066

CEJN reserves the right to make changes without further notification. Check with an authorized CEJN distributor for availability and prices. All measurements are in mm. Please visit our website, [www.cejn.com](http://www.cejn.com), for general maintenance tips.





QR code for Multi-Couplings

## Multi-X Coupling and Nipple Kits

The couplings and nipples in the Multi-X plates can be replaced. The nipple kit contains nipple and retaining ring. The coupling kit contains a complete set of parts for replacement of one coupling. The seal kits contains one profile ring or an O-ring/backup ring to replace the front seal on the nipple.

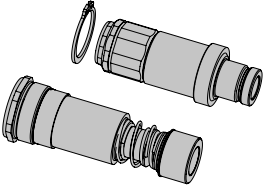
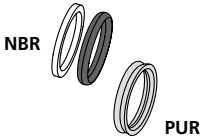
		Size DN	Suitable for	Part No.	WEO Connection
Multi-X Coupling and Nipple kits 	Nipple kit	10	Multi-X Duo 10 Multi-X Quattro 10 Multi-X Quattro 10/12.5 Multi-X Hexa 10	10 364 6904	3/8" (DN 10)
		12.5	Multi-X Duo 12.5 Multi-X Quattro 12.5 Multi-X Quattro 10/12.5 Multi-X Quattro 12.5/19	10 564 6905	1/2" (DN 12.5)
		19	Multi-X Quattro 12.5/19 Multi-X Duo 19	10 764 6901	3/4" (DN 19)
	Coupling kit	10	Multi-X Duo 10 Multi-X Quattro 10 Multi-X Hexa 10	10 365 1905	1/2" (DN 10)
			Multi-X Quattro 10/12.5	10 365 1906	1/2" (DN 10)
		12.5	Multi-X Duo 12.5 Multi-X Quattro 12.5 Multi-X Quattro 10/12.5 Multi-X Quattro 12.5/19	10 565 1907	3/4" (DN 12.5)
19	Multi-X Quattro 12.5/19 Multi-X Duo 19	10 765 1901	3/4" (DN 19)		
Seal kits for nipples 	Multi-X Seal kits	10	Nipple DN 10	10 365 4900	NBR
				10 365 4991	PUR
		12.5	Nipple DN 12.5	10 565 4900	NBR
				10 565 4991	PUR
		19	Nipple DN 19	10 765 4900	NBR
				10 765 4991	PUR

## Multi-X Mounting Bracket

The mounting bracket is enclosed with all female Multi-X plates as standard, but can be used with both the female or male plate.

**Material** ..... Powder coated steel

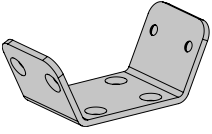
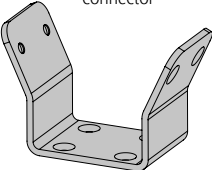
	Suitable for	Part No.
Mounting Bracket for Female/Male Plates 	Multi-X Duo 10	10 932 4963
	Multi-X Quattro 10	10 932 4965
	Multi-X Duo 12.5	10 932 4973
	Multi-X Quattro 12.5 Multi-X Quattro 10/12.5	10 932 4975
	Multi-X Quattro 12.5/19 Multi-X Duo 19 Multi-X Hexa 10	10 932 4985
Mounting Bracket for Female/Male Plates with electrical connector 	Multi-X Duo 10	10 932 4964
	Multi-X Quattro 10	10 932 4966
	Multi-X Duo 12.5	10 932 4974
	Multi-X Quattro 12.5 Multi-X Quattro 10/12.5	10 932 4976
	Multi-X Quattro 12.5/19 Multi-X Duo 19 Multi-X Hexa 10	10 932 4986

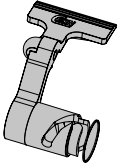
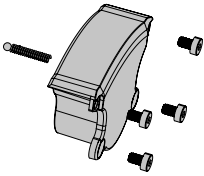
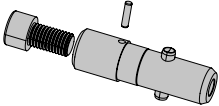
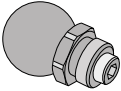
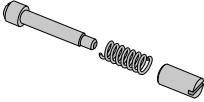
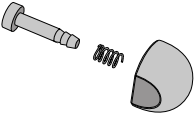
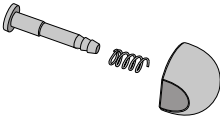

## Multi-X Spare Parts

	Suitable for	Part No.
Lever assembly 	Multi-X Duo 10 Multi-X Quattro 10	10 932 4960
	Multi-X Duo 12.5 Multi-X Quattro 12.5 Multi-X Quattro 10/12.5	10 932 4970
	Multi-X Quattro 12.5/19 Multi-X Duo 10	10 932 4980
	Multi-X Hexa 10	10 932 4983
Back lid kit 	Multi-X Duo 10 Multi-X Quattro 10	10 932 4961
	Multi-X Duo 12.5 Multi-X Quattro 12.5 Multi-X Quattro 10/12.5	10 932 4971
	Multi-X Quattro 12.5/19 Multi-X Duo 19 Multi-X Hexa 10	10 932 4981
Center bolt kit 	Multi-X Duo 10 Multi-X Quattro 10	10 932 4962
	Multi-X Duo 12.5 Multi-X Quattro 12.5 Multi-X Quattro 10/12.5	10 932 4972
	Multi-X Quattro 12.5/19 Multi-X Duo 19	10 932 4982
	Multi-X Hexa 10	10 932 4984
Locking Device 	Multi-X Cover/Parking Dock for Male Plate	10 932 4991
Lock in house 	All Female Multi-X models	10 932 4992
Lock set handle size 1 	Multi-X Duo 10 & 12.5 Multi-X Quattro 10 Multi-X Quattro 10/12.5 Multi-X Quattro 12.5	10 932 4993
Lock set handle size 2 	Multi-X Quattro 12.5/19 Multi-X Duo 19 Multi-X Hexa 10	10 932 4994

## Multi-X Slot Nut Kit

Multi-X Slot Nut Kit can be fitted on both the male and the female plate. For use in high vibration applications where standard nuts are insufficient.

	Suitable for	Part No.
	All sizes	10 932 4977

# Choose connection



QR code for Multi-Couplings

## WEO-NIPPLES WITH THREAD CONNECTIONS

Multi-X Part No./Description	Multi-X Connection	Choose your connection	WEO Part No.
10 932 2050 10 932 3050	WEO 3/8"	3/8" (BSP) Female	14 721 0606
		1/2" (BSP) Female	14 721 0608
		9/16"-18 JIC	14 727 0609
		3/4"-16 JIC	14 727 0612
10 932 2000 10 932 2051 10 932 3000 10 932 4051	WEO 1/2"	3/8" (BSP) Female	14 721 0806
		1/2" (BSP) Female	14 721 0848
		9/16"-18 JIC	14 727 0809
		3/4"-16 JIC	14 727 0812
10 932 2001 10 932 4001 10 932 5000 10 932 5002 10 932 5052	WEO 3/4"	1/2" (BSP) Female	14 721 1208
		3/4" (BSP) Female	14 721 1212
		1 1/16"-12 JIC	14 727 1217
10 932 4050	WEO 3/8"	3/8" (BSP) Female	14 721 0606
		1/2" (BSP) Female	14 721 0608
		9/16"-18 JIC	14 727 0609
		3/4"-16 JIC	14 727 0612
	WEO 1/2"	3/8" (BSP) Female	14 721 0806
		1/2" (BSP) Female	14 721 0848
		9/16"-18 JIC	14 727 0809
		3/4"-16 JIC	14 727 0812
10 932 4000 10 932 5050	WEO 1/2"	3/8" (BSP) Female	14 721 0806
		1/2" (BSP) Female	14 721 0848
		9/16"-18 JIC	14 727 0809
	WEO 3/4"	3/4" (BSP) Female	14 721 1208
		3/4" (BSP) Female	14 721 1212
		1 1/16"-12 JIC	14 727 1217



## WEO-NIPPLES WITH HYDRAULIC HOSE CONNECTION

Multi-X Part No./Description	Multi-X Connection	Hose Connection	Straight nipple	WEO Nipple 45°	WEO Nipple 90°
10 932 2050 10 932 3050	WEO 3/8"	DN06 (1/4")	14 710 0604		
		DN10 (3/8")	14 710 0606	14 712 0606	14 714 0606
10 932 2000 10 932 2051 10 932 3000 10 932 4051	WEO 1/2"	DN10 (3/8")	14 710 0806		14 714 0806
		DN12 (1/2")	14 710 0808	14 712 0808	14 714 0808
		DN12 (1/2")	14 710 1208		
10 932 2001 10 932 4001 10 932 5000 10 932 5002 10 932 5052	WEO 3/4"	DN20 (3/4")	14 710 1212		
10 932 4050	WEO 3/8"	DN06 (1/4")	14 710 0604		
		DN10 (3/8")	14 710 0606	14 712 0606	14 714 0606
	WEO 1/2"	DN10 (3/8")	14 710 0806		14 714 0806
		DN12 (1/2")	14 710 0808	14 712 0808	14 714 0808
10 932 4000 10 932 5050	WEO 1/2"	DN10 (3/8")	14 710 0806		14 714 0806
		DN12 (1/2")	14 710 0808	14 712 0808	14 714 0808
	WEO 3/4"	DN12 (1/2")	14 710 1208		
		DN20 (3/4")	14 710 1212		

CEJN reserves the right to make changes without further notification. Check with an authorized CEJN distributor for availability and prices. All measurements are in mm. Thread connections are listed according to ISO Standards. Please visit our website, [www.cejn.com](http://www.cejn.com), for general maintenance tips.



# Plug-In Fittings

## WEO Plug-In Fittings

- A smart Plug-In solution with extensive cost savings for everyone

### NO MATTER WHERE IN THE CHAIN, WEO WILL SIMPLY MAKE YOUR LIFE EASIER

*WEO offers the possibility of more compact designs, shorter maintenance times and minimizes the risk of work related injuries. It all adds up to extensive cost savings and benefits for everyone - the designer, manufacturer and end-user.*

**At the drawing board:** Through its minimal space requirements designers have the possibility to design new compact systems. How? Since our fittings are simply plugged in, you don't have to worry about hand-tool clearance. Traditional screw to connect fittings require extra space when tightened, but WEO will make it easier for you to build a compact and reliable hydraulic system. With WEO at the drawing board stage, you also cut time on the production line.

**On the production line:** CEJN WEO Plug-In hose fittings reduce downtime and installation time for equipment manufacturers. The click-to-connect and self-aligning features of the fittings make them easy to install in hydraulic systems, dramatically reducing costs through their quick installation time. Once it has been plugged in, the fitting locks into place, eliminating the need for tightening during follow-up security checks. The tight connection also gives you leak-free connections.

**Owner of WEO-equipped machine:** A machine equipped WEO will save you both time and money. Due to the fact that WEO fittings are self-aligning, twisted hose is no longer a problem giving your hose an extend service life. If necessary, disconnection can be achieved using nothing more than a simple screw driver, it's as easy as that! When plugged back in, the tight connection ensures leakage is virtually eliminated leaving you with a clog-free system. You can always rest assured the fittings are properly plugged in and don't have to worry about re-tightening.





## TECHNICAL DATA

### Tests

WEO Plug-In hose fittings have been tested and approved by the Swedish Institute of Materials Testing and Research to SS-ISO 8032 – Half Omega Test, and have been burst tested to a minimum pressure of four times the working pressure. The fittings have also been tested and approved by TÜV, Germany.

**Material seal**..... Nitrile (NBR), other sealing materials on request

**Temperature range** ..... -30°C 100°C -22°F 212°F

### Working Pressure, Safety Factor

WEO fitting sizes 1/4 inch through 3/4 inch have a maximum working pressure of 350 bar (5075 PSI). The 1-inch size has a maximum working pressure of 250 bar (3625 PSI). A minimum safety factor of 4:1 between burst pressure and working pressure applies to all sizes.

Note: Working pressure may vary among sizes. Refer to the data for each product range.

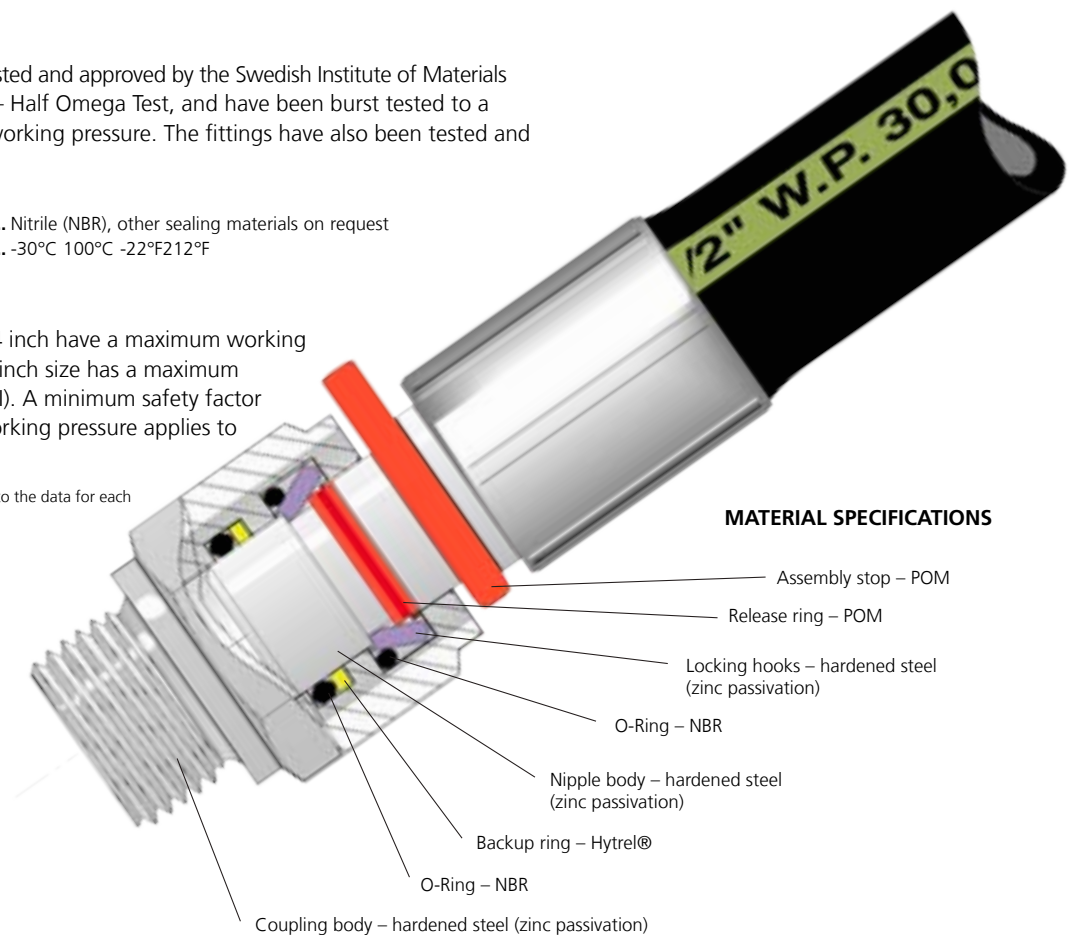

### MATERIAL SPECIFICATIONS

Assembly stop – POM

Release ring – POM

Locking hooks – hardened steel  
(zinc passivation)

O-Ring – NBR

Nipple body – hardened steel  
(zinc passivation)

Backup ring – Hytrel®

O-Ring – NBR

Coupling body – hardened steel (zinc passivation)

# Cartridge



QR code for Plug-In Fittings - Cartridge

The Flexible Solution will reduce your costs

- **Plug-In Cartridge**
- **Working Pressure up to 350 bar (5075 PSI)**
- **Cut assembly and test times**
- **Make more compact hydraulic components and system designs**
- **Shorten maintenance times and minimize work-related injuries**
- **It all adds up to extensive cost savings for all involved**

Plug-In systems for hydraulic hose are fast breaking new grounds and more and more equipment and component manufacturers worldwide are turning to the WEO Plug-In System to cut both assembly times and space requirements, as well as providing their customers with equipment made for easy servicing and minimal downtimes.

WEO Plug-In Cartridge is easily integrated into hydraulic components without interfering with the performance or quality. By using the integrated cartridge you get easy and effective assembly and testing, which will reduce your costs. The innovative cartridge cuts space requirements even more by eliminating the need for adapters or female fittings – just Plug-In!

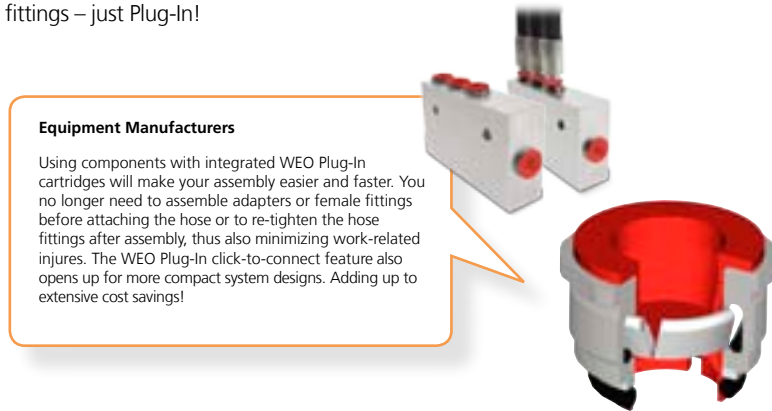

**Equipment Manufacturers**

Using components with integrated WEO Plug-In cartridges will make your assembly easier and faster. You no longer need to assemble adapters or female fittings before attaching the hose or to re-tighten the hose fittings after assembly, thus also minimizing work-related injuries. The WEO Plug-In click-to-connect feature also opens up for more compact system designs. Adding up to extensive cost savings!

**Component Manufacturers**

Integrating the WEO Plug-In Cartridge in your components means selling and delivering cost saving benefits to your customer. With no adapters or female fittings necessary for assembly you'll also make your own testing procedures quick and easy without compromising quality. Adding up to cost savings and new business opportunities

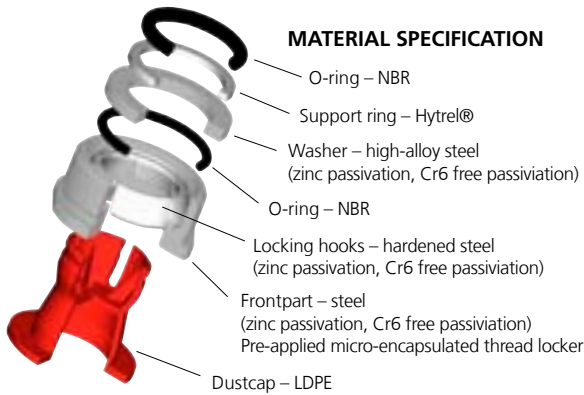

- Material coupling**..... Steel (zinc passivation, Cr6 free passivation)
- Max. working pressure**..... 350 bar (5076 PSI)
- Min. burst pressure**..... 1400 bar (20305 PSI)
- Temperature range** ..... -30°C – +100°C (-22°F – +212°F)

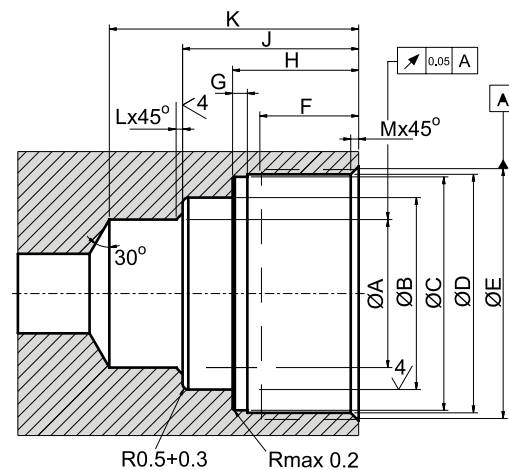

Size	Part No.	A	B	C	D	E	F	G	H	J	K	Rec. torque (Nm)
1/4"	14 800 0400	10.03+0.08	12.75+0.1	16.55+0.07	17.0+0.1	M18x1	8.5+1	1.1-0.1	10.65+0.1	14.15+0.2	19.65+0.15	25-35 Nm
3/8"	14 800 0600	13.03+0.08	16.95+0.15	20.55+0.07	21.0+0.1	M22x1	8.7+1	1.15-0.1	11.1+0.1	15.5+0.2	21.95+0.15	30-40 Nm
1/2"	14 800 0800	16.03+0.08	19.95+0.15	23.55+0.07	24.0+0.1	M25x1	8.7+1	1.25-0.1	11.3+0.1	15.7+0.2	22.15+0.15	40-50 Nm
3/4"	14 800 1200	23.03+0.08	27.95+0.15	31.05+0.07	31.5+0.1	M33x1.5	11.5+1	1.7-0.1	16.5+0.1	21.4+0.2	31.35+0.15	70-80 Nm

CEJN reserves the right to make changes without further notification. Check with an authorized CEJN distributor for availability and prices. All measurements are in mm. Please visit our website, www.cejn.com, for general maintenance tips.

# Nipples

## Series 710 – Straight, Nipple with Hose Connection

Series 710 features Plug-In nipples with straight hose connections for one/two wire braided hydraulic hose in sizes 1/4" to 1"

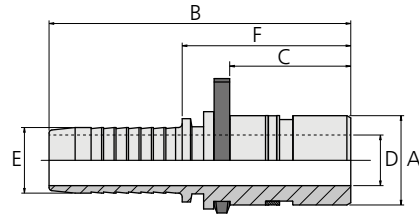

	E			A	B	C	D	F
	Part No.	Connection	Max working pressure					
Nipple, 1/4"	14 710 0403	3/16" (5.25 mm)	350 bar (5076 PSI)	10.0	54.5	19.0	2.8	29.2
	14 710 0404	1/4" (6.9 mm)	350 bar (5076 PSI)	10.0	58.0	19.0	4.5	30.0
Nipple, 3/8"	14 710 0604	1/4" (6.9 mm)	350 bar (5076 PSI)	13.0	61.0	22.0	4.5	33.0
	14 710 0605	5/16" (8.6 mm)	350 bar (5076 PSI)	13.0	61.0	22.0	5.6	33.0
	14 710 0606	3/8" (10.1 mm)	350 bar (5076 PSI)	13.0	63.0	22.0	7.0	33.0
Nipple, 1/2"	14 710 0806	3/8" (10.1 mm)	350 bar (5076 PSI)	16.0	63.0	22.0	7.0	33.0
	14 710 0808	1/2" (13.6 mm)	350 bar (5076 PSI)	16.0	64.0	22.0	9.5	33.0
	14 710 0810	5/8" (16.8 mm)	350 bar (5076 PSI)	15.9	68.5	22.0	9.5	34.3
Nipple, 3/4"	14 710 1208	1/2" (13.6 mm)	350 bar (5076 PSI)	23.0	73.5	31.0	9.5	42.5
	14 710 1210	5/8" (16.8 mm)	350 bar (5076 PSI)	23.0	77.5	31.0	12.0	43.3
	14 710 1212	3/4" (20 mm)	350 bar (5076 PSI)	23.0	82.0	31.0	15.0	43.0
Nipple, 1"	14 710 1616	1" (26.2 mm)	250 bar (3625 PSI)	30.0	100.5	38.5	21.0	54.0

## Series 712 – 45°, Nipple with Hose Connection

Series 712 features Plug-In nipples with 45° hose connections for one/two wire braided hydraulic hose in sizes 1/4" to 3/4"

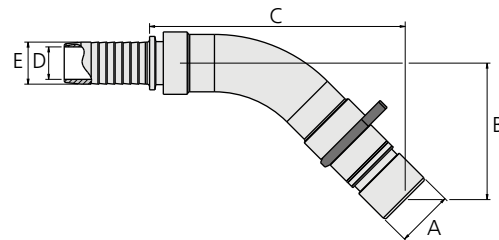

	E			A	B	C	D
	Part No.	Connection	Max working pressure				
Nipple, 1/4"	14 712 0404	1/4" (6.9 mm)	350 bar (5076 PSI)	10.0	28.0	51.0	4.5
Nipple, 3/8"	14 712 0604	1/4" (6.9 mm)	350 bar (5076 PSI)	13.0	32.0	55.0	4.5
	14 712 0605	5/16" (8.6 mm)	350 bar (5076 PSI)	13.0	33.0	54.5	5.6
	14 712 0606	3/8" (10.1 mm)	350 bar (5076 PSI)	13.0	33.0	59.0	7.0
Nipple, 1/2"	14 712 0806	3/8" (10.1 mm)	350 bar (5076 PSI)	16.0	34.0	60.0	7.0
	14 712 0808	1/2" (13.6 mm)	350 bar (5076 PSI)	16.0	36.0	66.0	9.0
Nipple, 3/4"	14 712 1208	3/4" (13.6 mm)	350 bar (5076 PSI)	23.0	44.0	73.0	9.0
	14 712 1210	5/8" (16.8 mm)	350 bar (5076 PSI)	23.0	55.0	103.0	13.0
	14 712 1212	3/4" (20.0 mm)	350 bar (5076 PSI)	23.0	55.0	103.0	15.0

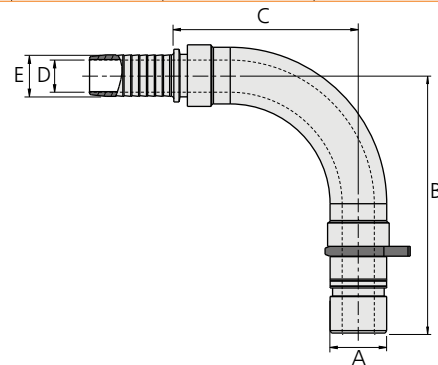

## Series 714 – 90°, Nipple with Hose Connection

Series 714 features Plug-In nipples with 90° hose connections for one/two wire braided hydraulic hose in sizes 1/4" to 3/4"

	E			A	B	C	D
	Part No.	Connection	Max working pressure				
Nipple, 1/4"	14 714 0404	1/4" (6.9 mm)	350 bar (5076 PSI)	10.0	51.0	34.0	4.5
Nipple, 3/8"	14 714 0604	1/4" (6.9 mm)	350 bar (5076 PSI)	13.0	56.0	34.0	4.5
	14 714 0605	5/16" (8.6 mm)	350 bar (5076 PSI)	13.0	60.0	39.0	5.6
	14 714 0606	3/8" (10.1 mm)	350 bar (5076 PSI)	13.0	60.0	39.0	7.0
Nipple, 1/2"	14 714 0805	5/16" (8.6 mm)	350 bar (5076 PSI)	16.0	62.0	39.0	5.6
	14 714 0806	3/8" (10.1 mm)	350 bar (5076 PSI)	16.0	61.0	39.0	7.0
	14 714 0808	1/2" (13.6 mm)	350 bar (5076 PSI)	16.0	69.0	48.0	9.0
Nipple, 3/4"	14 714 1208	1/2" (13.6 mm)	350 bar (5076 PSI)	23.0	79.0	48.0	9.0
	14 714 1210	5/8" (16.8 mm)	350 bar (5076 PSI)	23.0	105.5	75.0	13.0
	14 714 1212	3/4" (20.0mm)	350 bar (5076 PSI)	23.0	104.5	75.0	14.5

# Nipples

## Series 721 – Female G-Thread

Series 721 features Plug-In nipples with female G-Thread (ISO 228/1) in size 3/8" to 3/4"

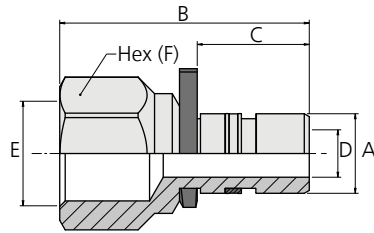

QR code for WEO Plug-In Fittings

	Part No.	Connection	Max working pressure	A	B	C	D	F
Nipple, 3/8"	14 721 0606	G 3/8" (10.1 mm)	350 bar (5076 PSI)	13.0	48.0	22.0	7.0	27.0
	14 721 0608	G 1/2" (13.6 mm)	350 bar (5076 PSI)	13.0	52.0	22.0	7.0	30.6
Nipple, 1/2"	14 721 0806	G 3/8" (10.1 mm)	350 bar (5076 PSI)	16.0	49.5	22.0	9.5	30.6
	14 721 0848	G 1/2" (13.6 mm)	350 bar (5076 PSI)	16.0	50.0	22.0	9.5	30.6
Nipple, 3/4"	14 721 1208	G 1/2" (13.6 mm)	350 bar (5076 PSI)	23.0	60.2	31.2	15.0	30.6
	14 721 1212	G 3/4" (20.0 mm)	350 bar (5076 PSI)	23.0	63.5	31.0	15.0	40.0

## Series 722 – Double Nipples

Series 722 features Plug-In nipples in size 1/4" to 1"

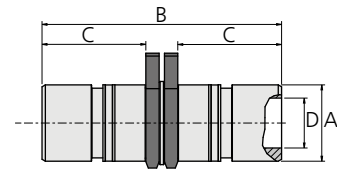

	Part No.	Connection	Max working pressure	A	B	C	D
Nipple, 1/4"	14 722 0404	WEO 1/4"	350 bar (5076 PSI)	10.0	45.0	22.0	4.5
Nipple, 3/8"	14 722 0606	WEO 3/8"	350 bar (5076 PSI)	13.0	53.5	26.0	7.0
Nipple, 1/2"	14 722 0808	WEO 1/2"	350 bar (5076 PSI)	16.0	53.5	26.0	9.5
Nipple, 3/4"	14 722 1212	WEO 3/4"	350 bar (5076 PSI)	22.9	72.0	35.0	15.0
Nipple, 1"	14 722 1616	WEO 1"	250 bar (3625 PSI)	30.0	89.0	43.5	21.0

## Series 723 – Male Blind Plug

Series 723 features Plug-In blind nipples in size 1/4" to 1"

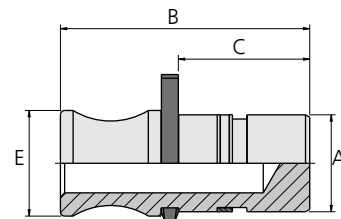

	Part No.	Connection	Max working pressure	A	B	C	E
Nipple, 1/4"	14 723 0400	-	350 bar (5076 PSI)	10.0	43.0	19.0	12.0
Nipple, 3/8"	14 723 0600	-	350 bar (5076 PSI)	13.0	50.0	22.0	16.0
Nipple, 1/2"	14 723 0800	-	350 bar (5076 PSI)	16.0	50.0	22.0	19.0
Nipple, 3/4"	14 723 1200	-	350 bar (5076 PSI)	23.0	59.0	31.0	25.0
Nipple, 1"	14 723 1600	-	250 bar (3625 PSI)	30.0	75.0	38.5	33.0

## Series 724 – Male G-Thread

DIN 3852-2 Type A

Series 724 features Plug-In nipples with male G-Thread (ISO 228/1) in size 1/4" to 1"

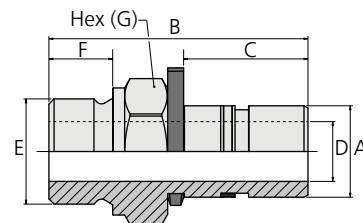

	Part No.	Connection	Max working pressure	A	B	C	D	F	G
Nipple, 1/4"	14 724 0404	G 1/4" (6.9 mm)	350 bar (5076 PSI)	10.0	43.0	19.3	4.5	12.0	19.0
Nipple, 3/8"	14 724 0606	G 3/8" (10.1 mm)	350 bar (5076 PSI)	13.0	43.0	22.0	7.0	12.0	22.0
Nipple, 1/2"	14 724 0808	G 1/2" (13.6 mm)	350 bar (5076 PSI)	16.0	52.0	22.5	9.5	14.0	27.0
Nipple, 3/4"	14 724 1212	G 3/4" (20.0 mm)	350 bar (5076 PSI)	23.0	65.0	31.2	15.0	16.0	32.0
Nipple, 1"	14 724 1616	G 1" (26.2 mm)	250 bar (3625 PSI)	30.0	77.0	41.0	21.5	38.5	41.0

# Nipples

## Series 727 – Male UNF-Thread

ISO 8434-2 (JIC 37°- SAE J514)

Series 727 features Plug-In nipples in size 1/4" to 3/4"

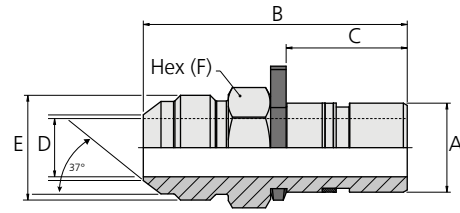

QR code for WEO Plug-In Fittings

	E							
	Part No.	Connection	Max working pressure	A	B	C	D	F
Nipple, 1/4"	14 727 0407	7/16" -20 UNF	350 bar (5076 PSI)	10.0	42.0	19.0	4.4	13
Nipple, 3/8"	14 727 0609	9/16"-18 UNF	250 bar (3625 PSI)	13.0	47.0	22.3	7.0	14
	14 727 0612	3/4"-16 UNF	250 bar (3625 PSI)	13.0	53.0	22.3	7.0	17
Nipple, 1/2"	14 727 0809	9/16" - 18 UNF	350 bar (5076 PSI)	13.0	47.0	22.3	7.0	16
	14 727 0812	3/4"-16 UNF	250 bar (3625 PSI)	16.0	52.0	22.0	9.5	20
	14 727 0813	7/8" - 14 UNF	350 bar (5076 PSI)	16.0	55.0	22.0	9.0	24
	14 727 0817	1 1/16" - 12 UNF	350 bar (5076 PSI)	16.0	62.0	22.0	9.5	30
Nipple, 3/4"	14 727 1217	1 1/16" - 12 UNF	200 bar (2900 PSI)	23.0	68.0	31.0	15.0	27

## Series 729 – Female NPTF-Thread

Series 729 features Plug-In nipples in size 3/8" to 3/4"

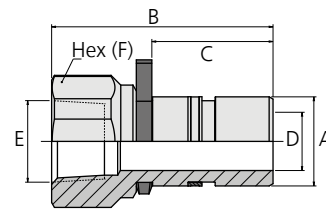

	E							
	Part No.	Connection	Max working pressure	A	B	C	D	F
Nipple, 3/8"	14 729 0608	1/2" NPTF (21 mm)	350 bar (5076 PSI)	13.0	50.0	22.0	7.0	22
Nipple, 1/2"	14 729 0808	1/2" NPTF (21 mm)	350 bar (5076 PSI)	16.0	50.0	22.0	9.5	22
Nipple, 3/4"	14 729 1208	1/2" NPTF (21 mm)	350 bar (5076 PSI)	23.0	57.0	31.0	15.0	31

## Series 744 – Male G-Thread, Integral NBR Rubber Seal

ISO 1179-2

Series 744 features Plug-In Nipples with male G-thread (ISO 228/1) in size 1/4" to 1"

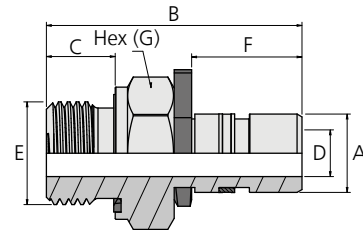

	E								
	Part No.	Connection	Max working pressure	A	B	C	D	F	G
Nipple, 1/4"	14 744 0404	G 1/4" (6.9 mm)	350 bar (5076 PSI)	10.0	43.0	12.0	4.5	19.3	19
Nipple, 3/8"	14 744 0606	G 3/8" (10.1 mm)	350 bar (5076 PSI)	13.0	50.0	12.0	7.0	22.3	22
Nipple, 1/2"	14 744 0808	G 1/2" (13.6 mm)	350 bar (5076 PSI)	16.0	52.0	14.0	9.5	22.5	27
Nipple, 3/4"	14 744 1212	G 3/4" (20 mm)	350 bar (5076 PSI)	23.0	65.0	16.0	15.0	31.0	36
Nipple, 1"	14 744 1616	G 1" (26.2 mm)	250 bar (3625 PSI)	30.0	77.0	18.0	21.0	38.5	41

# Couplings

## Series 810 – Male G-Thread

DIN 3852-2 Type A

Series 810 features Plug-In couplings with male G-thread (ISO 228/1)

in sizes 1/4" up to 1"

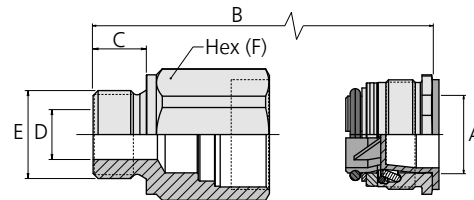

	E							
	Part No.	Connection	Max working pressure	A	B	C	D	F
Coupling, 1/4"	14 810 0404	G 1/4" (6.9 mm)	350 bar (5076 PSI)	10.0	38.4	12.0	4.5	20
Coupling, 3/8"	14 810 0606	G 3/8" (10.1 mm)	350 bar (5076 PSI)	13.0	41.9	12.0	7.0	24
Coupling, 1/2"	14 810 0808	G 1/2" (13.6 mm)	350 bar (5076 PSI)	16.0	43.5	14.0	9.5	28
Coupling, 3/4"	14 810 1212	G 3/4" (20 mm)	350 bar (5076 PSI)	23.0	56.0	16.0	9.5	36
Coupling, 1"	14 810 1616	G 1" (26.2 mm)	250 bar (3625 PSI)	30.0	67.0	18.0	21.0	41

CEJN reserves the right to make changes without further notification. Check with an authorized CEJN distributor for availability and prices. All measurements are in mm. Please visit our website, [www.cejn.com](http://www.cejn.com), for general maintenance tips.





# Couplings

## Series 811 – Female Blind Plug

Series 811 features Plug-In blind coupling in sizes 1/4" up to 1"

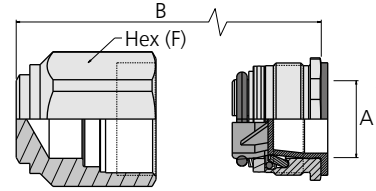

	E			A	B	F
	Part No.	Connection	Max working pressure			
Coupling, 1/4"	14 811 0400	G 1/4" (6.9 mm)	350 bar (5076 PSI)	10.0	29.4	20
Coupling, 3/8"	14 811 0600	G 3/8" (10.1 mm)	350 bar (5076 PSI)	13.0	31.3	24
Coupling, 1/2"	14 811 0800	G 1/2" (13.6 mm)	350 bar (5076 PSI)	16.0	32.3	28
Coupling, 3/4"	14 811 1200	G 3/4" (20 mm)	350 bar (5076 PSI)	23.0	44.0	32
Coupling, 1"	14 811 1600	G 1" (26.2 mm)	250 bar (3625 PSI)	30.0	55.0	41

## Series 813 – Bulkhead, male M-Thread

Series 813 features Plug-In bulkhead couplings in sizes 1/4" up to 1"

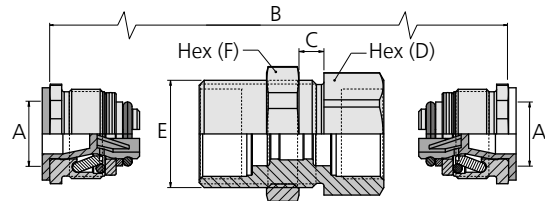

	E			A	B	C	D	F
	Part No.	Connection	Max working pressure					
Coupling, 1/4"	14 813 0444	M20x1.5	350 bar (5076 PSI)	10.0	42.8	0-18	22	25
Coupling, 3/8"	14 813 0646	M26x1.5	350 bar (5076 PSI)	13.0	50.8	0-25	27	30
Coupling, 1/2"	14 813 0848	M30x2	350 bar (5076 PSI)	16.0	50.0	0-25	32	36
Coupling, 3/4"	14 813 1242	M39x2	350 bar (5076 PSI)	23.0	68.0	0-25	41	45
Coupling, 1"	14 813 1646	M45x2	250 bar (3625 PSI)	30.0	84.0	0-25	55	55

## Series 817 – Straight Hose Connection

Series 817 features Plug-In couplings with straight hose connections for one/two wire braided hydraulic hose in sizes 1/4" up to 1"

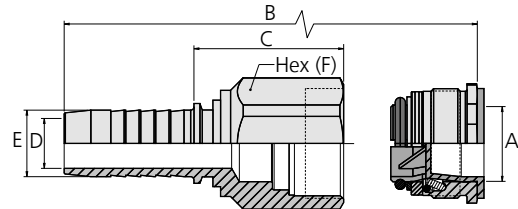

	E			A	B	C	D	F
	Part No.	Connection	Max working pressure					
Coupling, 1/4"	14 817 0404	1/4" (6.9 mm)	350 bar (5076 PSI)	10.0	58.5	33.2	2.8	20
Coupling, 3/8"	14 817 0606	3/8" (10.1 mm)	350 bar (5076 PSI)	13.0	66.9	36.0	7.0	24
Coupling, 1/2"	14 817 0808	1/2" (13.6 mm)	350 bar (5076 PSI)	16.0	67.0	36.3	9.5	28
Coupling, 3/4"	14 817 1212	3/4" (20 mm)	350 bar (5076 PSI)	23.0	87.0	48.0	15.0	32
Coupling, 1"	14 817 1616	1" (26.2 mm)	250 bar (3625 PSI)	30.0	105.0	58.5	21.0	41

## Series 822 – Female 24° cone, Male M-Thread

ISO 8434-1

Series 822 features Plug-In couplings in sizes 1/4" up to 3/4"

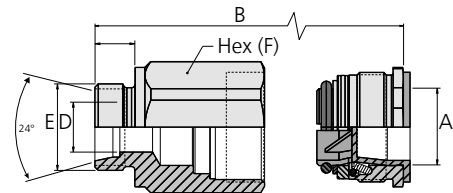

	E			A	B	C	D	F
	Part No.	Connection	Max working pressure					
Coupling, 1/4"	14 822 0412	M12x1.5	250 bar (3625 PSI)	17.0	33.5	10.0	4.0	22
	14 822 0414	M14x1.5	250 bar (3625 PSI)	17.0	33.5	10.0	5.0	20
	14 822 0415	M14x1.5	250 bar (3625 PSI)	17.0	33.5	10.0	5.0	20
Coupling, 3/8"	14 822 0618	M18x1.5	250 bar (3625 PSI)	21.0	37.5	11.0	9.0	24
	14 822 0619	M18x1.5	250 bar (3625 PSI)	21.0	37.5	11.0	9.0	24
Coupling, 1/2"	14 822 0822	M22x1.5	250 bar (3625 PSI)	24.0	38.5	12.0	12.0	28
	14 822 0823	M22x1.5	250 bar (3625 PSI)	24.0	38.5	12.0	12.0	28
Coupling, 3/4"	14 822 1227	M26x1.5	160 bar (2320 PSI)	31.5	51.0	12.0	15.0	36
	14 822 1230	M30x2 - 24°	160 bar (2320 PSI)	31.5	51.0	14.0	18.0	36

# Couplings

## Series 824 – Male 37° cone, Male UNF-Thread

ISO 8434-2 (JIC 37°- SAE J514)

Series 824 features Plug-In couplings with UNF-thread in sizes 1/4" up to 3/4"

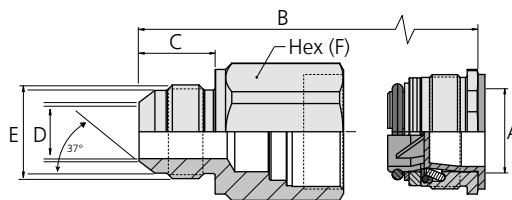

QR code for WEO Plug-In Fittings

	E			A	B	C	D	F
	Part No.	Connection	Max working pressure					
Coupling, 1/4"	14 824 0407	7/16" -20 UNF	350 bar (5076 PSI)	15.6	40.0	14.0	4.4	19
Coupling, 3/8"	14 824 0609	9/16" -18 UNF	250 bar (3625 PSI)	18.6	43.1	14.1	7.5	22
Coupling, 1/2"	14 824 0812	3/4" -16 UNF	310 bar (4496 PSI)	24.0	43.2	16.7	9.9	28
	14 824 0814	7/8" -14 UNF	240 bar (3480 PSI)	24.0	45.8	19.3	12.3	28
	14 824 0817	1 1/16" -12 UN	200 bar (2900 PSI)	21.6	50.9	21.9	15.0	30
Coupling, 3/4"	14 824 1217	1 1/16" -12 UN	200 bar (2900 PSI)	31.5	58.9	21.9	15.5	36

## Series 826 – Male UNF-Thread, O-Ring Boss

ISO 11926-3 (SAE J1926-3 / former SAE J514 ORB)

Series 826 features Plug-In couplings with O-ring Boss in sizes 1/4" up to 1". Including NBR O-ring.

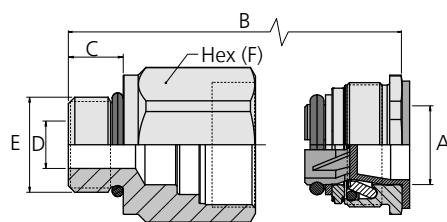

	E			A	B	C	D	F
	Part No.	Connection	Max working pressure					
Coupling, 1/4"	14 826 0407	7/16" -20 UNF	350 bar (5076 PSI)	10.0	35.4	9.0	4.5	20
Coupling, 3/8"	14 826 0609	9/16" -18 UNF	350 bar (5076 PSI)	13.0	39.9	10.0	7.0	24
Coupling, 1/2"	14 826 0812	3/4" -16 UNF	350 bar (5076 PSI)	16.0	40.5	11.0	9.5	28
	14 826 0814	7/8" -14 UNF	350 bar (5076 PSI)	16.0	42.1	12.6	12.7	28
	14 826 0817	1 1/16" -12 UN	350 bar (5076 PSI)	16.0	44.5	15.0	14.5	28
Coupling, 3/4"	14 826 1217	1 1/16" -12 UN	350 bar (5076 PSI)	23.0	55.0	15.0	15.0	32
Coupling, 1"	14 826 1621	1 5/16" -12 UN	250 bar (3625 PSI)	30.0	64.0	15.0	21.0	41

## Series 830 – Male G-Thread, Integral NBR Rubber Seal

ISO 1179-2

Series 830 features Plug-In couplings with male G-thread (ISO 228/1) with integral rubber seal in sizes 1/4" up to 1"

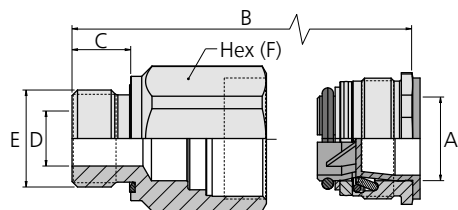

	E			A	B	C	D	F
	Part No.	Connection	Max working pressure					
Coupling, 1/4"	14 830 0404	G 1/4"	350 bar (5076 PSI)	10.0	38.0	12.0	4.5	20
	14 830 0406	G 3/8"	350 bar (5076 PSI)	17.0	35.5	12.0	7.0	22
Coupling, 3/8"	14 830 0604	G 1/4"	350 bar (5076 PSI)	21.0	38.5	12.0	4.5	24
	14 830 0606	G 3/8"	350 bar (5076 PSI)	13.0	41.0	12.0	7.0	24
	14 830 0608	G 1/2"	350 bar (5076 PSI)	13.0	43.4	14.0	9.5	24
Coupling, 1/2"	14 830 0806	G 3/8"	350 bar (5076 PSI)	16.0	42.0	12.0	8.0	28
	14 830 0808	G 1/2"	350 bar (5076 PSI)	16.0	43.0	14.0	9.5	28
	14 830 0812	G 3/4"	350 bar (5076 PSI)	16.0	45.0	16.0	9.5	32
Coupling, 3/4"	14 830 1208	G 1/2"	350 bar (5076 PSI)	23.0	56.0	14.0	9.5	36
	14 830 1212	G 3/4"	350 bar (5076 PSI)	23.0	56.0	16.0	15.0	34
	14 830 1216	G 1"	350 bar (5076 PSI)	23.0	56.0	18.0	15.0	41
Coupling, 1"	14 830 1616	G 1"	250 bar (3625 PSI)	30.0	69.0	18.0	21.0	41



# Couplings

## Series 831 – Male M-Thread, O-Ring Boss

ISO 6149-3

Series 831 features Plug-In couplings with male metric thread in sizes 1/4" up to 3/4". Including NBR O-ring.

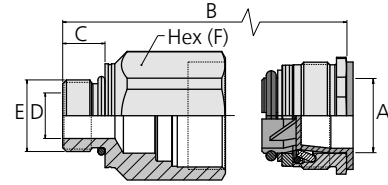

	Part No.	Connection	Max working pressure	A	B	C	D	F
Coupling, 1/4"	14 831 0412	M12x1.5 male	350 bar (5076 PSI)	10.0	36.9	11.0	6.0	20
	14 831 0414	M14x1.5 male	350 bar (5076 PSI)	10.0	37.0	11.0	7.5	20
Coupling, 3/8"	14 831 0612	M12x1.5 male	315 bar (4568 PSI)	13.0	42.0	12.5	9.5	27
	14 831 0616	M16x1.5 male	315 bar (4568 PSI)	13.0	41.4	11.5	7.5	24
Coupling, 1/2"	14 831 0818	M18x1.5 male	315 bar (4568 PSI)	16.0	42.0	12.5	9.5	27
	14 831 0858	M22x1.5 male	315 bar (4568 PSI)	16.0	42.0	13.0	14.0	28
Coupling, 3/4"	14 831 1222	M22x1.5 male	315 bar (4568 PSI)	23.0	53.0	13.0	14.0	32
	14 831 1227	M27x2 male	200 bar (2900 PSI)	23.0	56.0	16.0	15.0	32

## Series 832 – Male G-Thread, Integral NBR Rubber Seal

ISO 1179-2

Series 832 features Plug-In couplings with male G-thread (ISO 228/1) with integral rubber seal in sizes 3/8" up to 1/2". Space saving round coupling housing with hexagon socket drive.

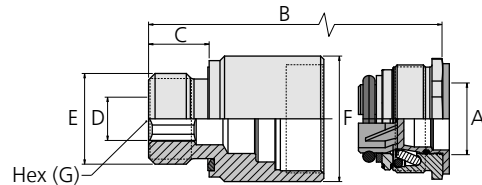

	Part No.	Connection	Max working pressure	A	B	C	D	F	G
Coupling, 3/8"	14 832 0646	G 3/8"	350 bar (5076 PSI)	13.0	41.4	12	8	25.5	8
Coupling, 1/2"	14 832 0846	G 3/8"	350 bar (5076 PSI)	16.0	40.5	12.0	9.5	29.0	8
	14 832 0848	G 1/2"	350 bar (5076 PSI)	16.0	43.3	14.0	10	29.0	10

## Series 837 – Male M-Thread, Integral NBR Rubber Seal

ISO 9974-2

Series 837 features Plug-In couplings with male M-thread with integral rubber seal in sizes 1/4" up to 1/2", including seal

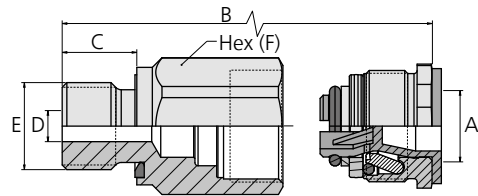

	Part No.	Connection	Max working pressure	A	B	C	D	F
Coupling, 1/4"	14 837 0412	M12x1.5	350 bar (5076 PSI)	17.0	35.5	12.0	4.5	20
	14 837 0414	M14x1.5	350 bar (5076 PSI)	17.0	35.5	12.0	5.0	20
Coupling, 1/2"	14 837 0818	M18x1.5	350 bar (5076 PSI)	24.0	41.0	12.0	9.5	28

## Series 840 – Female G-Thread

Series 840 features Plug-In couplings with female G-thread (ISO 228/1) in sizes 1/4" up to 3/4"

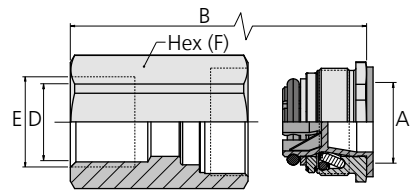

	Part No.	Connection	Max working pressure	A	B	C	F
Coupling, 1/4"	14 840 0404	G 1/4"	350 bar (5076 PSI)	17.0	34.7	17.0	20
Coupling, 3/8"	14 840 0606	G 3/8"	350 bar (5076 PSI)	21.0	37.0	13.0	24
Coupling, 1/2"	14 840 0808	G 1/2"	350 bar (5076 PSI)	24.0	41.3	16.0	28
Coupling, 3/4"	14 840 1212	G 3/4"	350 bar (5076 PSI)	24.0	41.3	16.0	28

# Couplings

## Series 850 – Female ORFS, UNIF-Thread

ISO 8434-3

Series 850 features Plug-In couplings with female O-ring face seal connectors in sizes 1/4" up to 3/4"

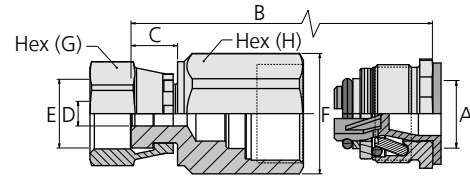

		E			A	B	C	D	F	G	H
Coupling, 1/4"	14 850 0406	9/16"-18 UNF	350 bar (5076 PSI)		17.0	34.0	8.5	4.5	22.0	17	20
Coupling, 3/8"	14 850 0610	11/16"-16 UN	350 bar (5076 PSI)		21.0	36.0	9.5	7.0	26.5	22	24
Coupling, 1/2"	14 850 0812	13/16"-16 UN	350 bar (5076 PSI)		24.0	36.0	10.5	9.5	31.0	24	28
Coupling, 3/4"	14 850 1220	13/16"-12 UN	350 bar (5076 PSI)		31.5	56.0	13.0	15.0	39.5	36	36

# Swivels

The WEO Plug-In swivel is a plug-in connector with integrated swivel function that absorbs movement in the hydraulic hose. The WEO Plug-In swivel can be turned 360°, prevents torque stress on the hydraulic hose and is specially adapted for modern compact hydraulic systems. The product is as small and flexible as the base version of WEO Plug-In but swivels freely up to full working pressure.



## Serie 860 – Swivel, Integral NBR Rubber Seal

ISO 1179-2

Series 860 features Plug-In swivel couplings with male G-thread (ISO 228/1) with internal rubber seal in sizes 3/8" up to 1". Only to be used with Series 716 nipples.

Material coupling..... Steel with Zinc-Nickel surface

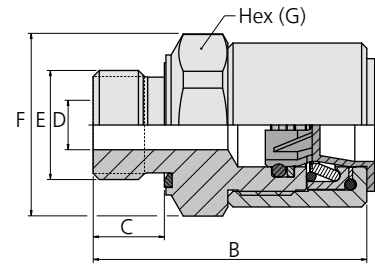

		E			A	B	C	D	F	G
Coupling, 3/8"	14 860 0606	G 3/8"	350 bar (5076 PSI)		13.0	47.1	12.0	7.0	27.0	27
Coupling, 1/2"	14 860 0808	G 1/2"	350 bar (5076 PSI)		16.0	52.6	14.0	9.5	32.0	32
Coupling, 3/4"	14 860 1222	G 3/4"	350 bar (5076 PSI)		23.0	67.0	16.0	15.0	41.0	41
Coupling, 1"	14 860 1616	G 1"	250 bar (3625 PSI)		30.0	74.6	16.0	21.0	50.0	50

# Nipples

## Series 716 – Straight Hose Connection

Series 716 features Plug-In nipples with straight hose connections for one/two wire braided hydraulic hose in sizes 3/8" to 1". This nipple series is specifically made to correspond to the WEO Plug-In swivel Series 860.

Material nipple..... Hardened steel with Zinc-Nickel surface

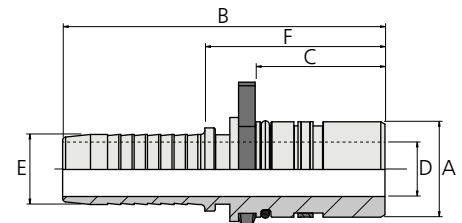

		E			A	B	C	D	F
Nipple, 3/8"	14 716 0616	3/8" (10.1 mm)	350 bar (5076 PSI)		13.0	63.0	22.3	6.5	33.0
Nipple, 1/2"	14 716 0818	1/2" (13.6 mm)	350 bar (5076 PSI)		16.0	64.0	22.5	9.0	33.0
Nipple, 3/4"	14 716 1222	3/4" (20.0 mm)	350 bar (5076 PSI)		23.0	82.0	31.2	15.0	43.0
Nipple, 1"	14 716 1626	1" (26.2 mm)	250 bar (3625 PSI)		30.0	100.5	38.5	21.0	54.0

CEJN reserves the right to make changes without further notification. Check with an authorized CEJN distributor for availability and prices. All measurements are in mm. Please visit our website, [www.cejn.com](http://www.cejn.com), for general maintenance tips.



# Conventional Quick Connect Couplings

**Classic Range** - *The CEJN unique performance coupling*

**Nordic Range** - *The high performance poppet type coupling*

## **THE CLASSIC RANGE IS A CEJN UNIQUE PRODUCT WITH SOME SPECIFICALLY GOOD FEATURES**

This coupling range has really small outer dimensions but yet a very good flow rate. The main reason why many customers use this coupling is the extremely low connection force. From an ergonomic point of view, this coupling series is outstanding and often chosen for applications where you have many connections and disconnections every day, for example, in hydraulic test benches. Compare and feel the difference!

## **NORDIC RANGE IS A HIGH PERFORMING AND ROBUST COUPLING**

This Series is made for the toughest of applications and is the preferred choice in the tough climate of Scandinavia. It is equipped with an additional security locking feature to protect against involuntary disconnection and has an extra sealing function to improve sealing performance. Nordic range is also available with a pressure eliminator in both coupling and nipple if you have residual pressure problems. In general, this is a coupling range with considerably higher specifications and performance than both ISO-A and ISO-B.



# Classic Range - CEJN Unique Profile



QR code for Classic Range - CEJN Unique Profile

DN 6.2 (Series 325), DN 8.9 (Series 415), DN 14.5 (Series 605), DN 19 (Series 705)

- One-hand operated
- Small external dimensions
- Extremely low connection force



Temperature range: ..... -30°C – +100°C (-22°F – +212°F)  
 Material seal:..... Nitrile (NBR), other sealing materials on request  
 Material: ..... Material coupling: Brass/steel (chrome plated),  
 Material nipple: Hardened steel (zinc passivation)  
 Connectability: ..... Without pressure  
 Disconnection under pressure: ..... Not allowed  
 Interchangeable with: ..... CEJN unique profile

Body Size			Series	Flow rate @ ΔP = 3 Bar		Max. working pressure				Min. burst pressure			
ISO - DN	Inch	Dash		(l/min)**	(GPM)**	Connected		Disconnected		Connected		Disconnected	
					(bar)	(PSI)	(bar)	(PSI)	(bar)	(PSI)	(bar)	(PSI)	
6.2	1/4"	-04	325	27	7.1	250	3625	100	1450	1000	14503	1000	14503
8.9	3/8"	-06	415	52	13.7	250	3625	100	1450	1000	14503	1000	14503
14.5	1/2"	-08	605	142	37.5	320	4641	100	1450	1000	14503	1000	14503
19	3/4"	-12	705	250	66.0	320	4641	100	1450	1000	14503	1000	14503

## COUPLINGS & NIPPLES

Size Nominal flow diameter			Seal	Connection			Part No.		Weight (g)		Package Qty.	
ISO	Inch	Dash		Description	Type	Standards	Coupling/Female	Nipple/Male	Coupling	Nipple	Coupling	Nipple
6.2	1/4"	-04	NBR (Nitrile)	G 1/4"	Female thread	DIN 3852	10 325 1202	10 325 6202	118	63	50	50
				1/4" NPT	Female thread	ANSI B1.20.1	10 325 1402	10 325 6402	118	64	50	50
8.9	3/8"	-06		G 3/8"	Female thread	DIN 3852	10 415 1204	10 415 6204	183	134	10	10
				G 1/2"	Female thread	DIN 3852	10 415 1205	10 415 6205	211	148	10	10
				3/8" NPT	Female thread	ANSI B1.20.1	10 415 1404	10 415 6404	183	136	10	10
				1/2" NPT	Female thread	ANSI B1.20.1	10 415 1405	10 415 6405	214	149	10	10
				G 3/8"	Male thread	ANSI B1.20.1	10 415 1254	10 415 6254	175	120	10	10
				G 1/2"	Male thread	ANSI B1.20.1	10 415 1255	10 415 6255	196	127	10	10
14.5	1/2"	-08		G 3/4"	Female thread	DIN 3852	10 605 1201	10 605 6201	628	313	1	1
				3/4" NPT	Female thread	ANSI B1.20.1	10 605 1401	10 605 6401	632	324	1	1
19	3/4"	-12		G 1"	Female thread	DIN3852	10 705 1203	10 705 6203	792	528	1	1
				1" NPT	Female thread	ANSI B1.20.1	10 705 1403	10 705 6403	812	554	1	1

## PRESSURE DROP CHART

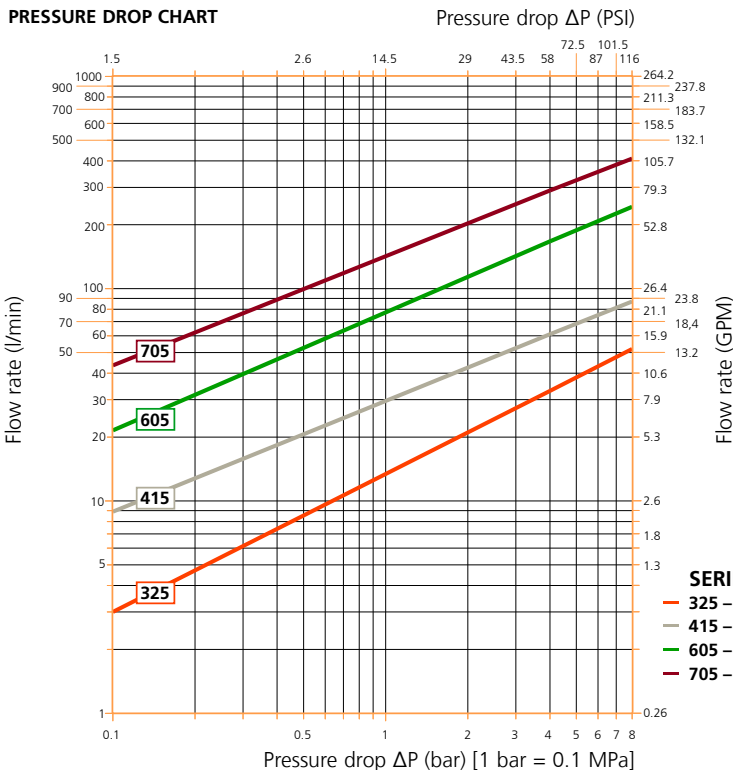

(\*\*) If the application is constantly above this flow rate for the respective coupling size, a larger coupling size should be considered to avoid too high a pressure drop. The couplings can handle a much higher flow rate during short time periods, but there is a risk of heat build-up in the system. In general, surge flows above the normal flow rate are not a problem.



- SERIES**
- 325 – DN6.2
  - 415 – DN8.9
  - 605 – DN14.5
  - 705 – DN19

CEJN reserves the right to make changes without further notification. Check with an authorized CEJN distributor for availability and prices. All measurements are in mm. Thread connections are listed according to ISO Standards. Please visit our website, [www.cejn.com](http://www.cejn.com), for general maintenance tips.



QR code for Nordic Range 525

# Nordic Range / 525 - High Performance Poppet Type Couplings

DN 6.3 (1/4"), DN10 (3/8"), DN 12.5 (1/2"), DN 20 (3/4"), DN 25 (1")

- Double sealing feature - no spray at connection
- High durability
- Extra security locking ring
- Optional pressure eliminator on both coupling and nipple

Temperature range: ..... -30°C – +100°C (-22°F – +212°F)

Material seal:..... Nitril (NBR) alt. FPM

Material: ..... Steel (zinc-nickel)

Connectability: ..... Without pressure (std Without Eliminator)

Disconnection under pressure: ..... Not allowed

Interchangeable with: ..... Parker Tema "T-Series"



Body Size			Flow rate @ ΔP = 3 Bar		Max. working pressure				Min. burst pressure			
ISO - DN	Inch	Dash	(l/min)**	(GPM)**	Connected		Disconnected		Connected		Disconnected	
					(bar)	(PSI)	(bar)	(PSI)	(bar)	(PSI)	(bar)	(PSI)
6.3	1/4"	-04	24	6.3	450	6526	300	4351	1800	26106	1200	17404
10	3/8"	-06	53	14.0	350	5076	280	4061	1300	18854	1100	15954
12.5	1/2"	-08	108	28.5	300	4351	250	3625	1100	15954	1000	14503
20	3/4"	-12	214	56.5	280	4061	200	2900	1000	14503	800	11603
25	1"	-16	322	85.1	250	3625	250	3625	930	13488	1000	14503

(\*\*) If the application is constantly above this flow rate for the respective coupling size, a larger coupling size should be considered to avoid too high a pressure drop. The couplings can handle a much higher flow rate during short time periods, but there is a risk of heat build-up in the system. In general, surge flows above the normal flow rate are not a problem.

## PRESSURE DROP CHART

Pressure drop ΔP (PSI)

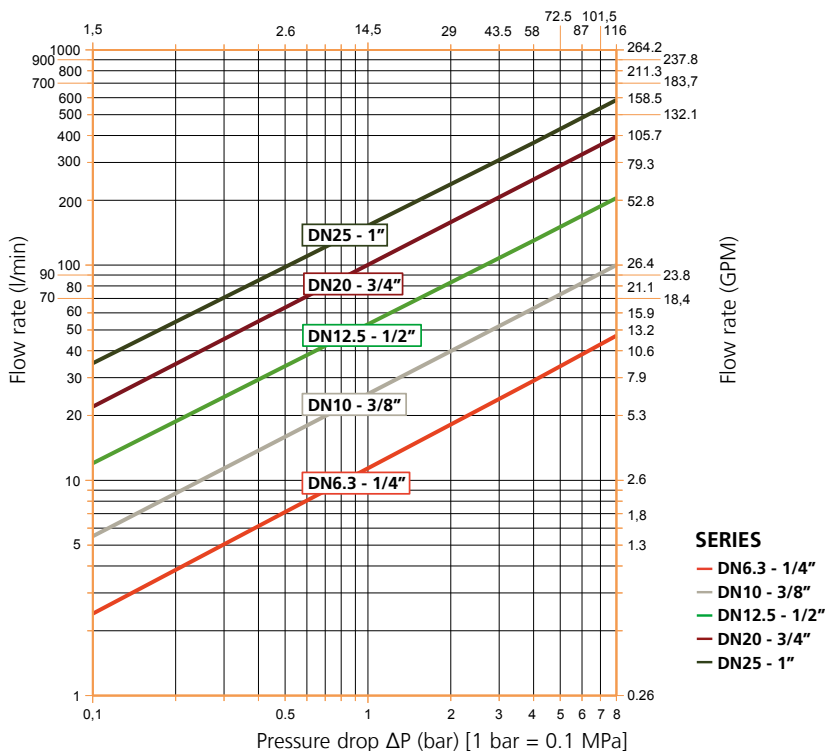

- SERIES**
- DN6.3 - 1/4"
  - DN10 - 3/8"
  - DN12.5 - 1/2"
  - DN20 - 3/4"
  - DN25 - 1"

**COUPLINGS & NIPPLES**

Body Size			Seal	Connection			Part No.		Weight (g)		Package Qty.	
DN	Inch	Dash		Description	Type	Standards	Coupling/Female	Nipple/Male	Coupling	Nipple	Coupling	Nipple
6.3	1/4"	-04	NBR	G 1/4"	Female thread	DIN 3852	10 525 1202	10 525 6202	148	53	10	10
			FPM		Female thread	DIN 3852	10 525 1212	10 525 6212	150	82	10	10
10	3/8"	-06	NBR	G 3/8"	Female thread	DIN 3852	10 525 1204	10 525 6204	225	59	10	10
			FPM		Female thread	DIN 3852	10 525 1214	10 525 6214	225	59	10	10
12.5	1/2"	-08	NBR	G 1/2"	Female thread	DIN 3852	10 525 1205	10 525 6205	340	99	10	10
			FPM		Female thread	DIN 3852	10 525 1215	10 525 6215	340	99	10	10
20	3/4"	-12	NBR	G 3/4"	Female thread	DIN 3852	10 525 1207	10 525 6207	595	192	10	10
			FPM		Female thread	DIN 3852	10 525 1217	10 525 6217	595	192	10	10
25	1"	-16	NBR	G 1"	Female thread	DIN 3852	10 525 1209	10 525 6209	1009	355	5	5
			FPM		Female thread	DIN 3852	10 525 1219	10 525 6219	1009	355	5	5

**COUPLINGS & NIPPLES WITH PRESSURE ELIMINATOR**

Body Size			Seal	Connection			Part No.		Weight (g)		Package Qty.	
DN	Inch	Dash		Description	Type	Standards	Coupling/Female	Nipple/Male	Coupling	Nipple	Coupling	Nipple
10	3/8"	-06	NBR	G 3/8"	Female thread	DIN 3852	10 525 1234	10 525 6234	225	59	10	10
12.5	1/2"	-08		G 1/2"	Female thread	DIN 3852	10 525 1235	10 525 6235	340	99	10	10
10	3/4"	-12		G 3/4"	Female thread	DIN 3852	10 525 1237	10 525 6237	594	190	10	10
25	1"	-16		G 1"	Female thread	DIN 3852	10 525 1239	10 525 6239	1006	357	5	5

**COUPLINGS & NIPPLES WITHOUT VALVE**

Body Size			Seal	Connection			Part No.		Weight (g)		Package Qty.	
DN	Inch	Dash		Description	Type	Standards	Coupling/Female	Nipple/Male	Coupling	Nipple	Coupling	Nipple
6.3	1/4"	-04	NBR	G 1/4"	Female thread	DIN 3852	10 525 0202	10 525 5202	138	46	10	10
10	3/8"	-06		G 3/8"	Female thread	DIN 3852	10 525 0204	10 525 5204	214	48	10	10
12.5	1/2"	-08		G 1/2"	Female thread	DIN 3852	10 525 0205	10 525 5205	320	82	10	10
20	3/4"	-12		G 3/4"	Female thread	DIN 3852	10 525 0207	10 525 5207	558	158	10	10
25	1"	-16		G 1"	Female thread	DIN 3852	10 525 0209	10 525 5209	920	300	5	5

**Nordic Range - Accessories**

- Dust caps for couplings and nipples
- Seal kits for couplings
- Fits all Nordic series

Included as accessories in the Nordic range are dust caps for both couplings and nipples and seal kits for couplings. The dust caps can be joined together when the coupling and nipple are connected. This keeps the dust caps clean, which prevents dust and debris from entering the system. The seal kits contain two O-rings and a backup ring for replacing the outer seals in the coupling.



		Part No.	Description
Seal kits for couplings	DN 6.3	10 525 4900	NBR
	DN 10	10 525 4901	NBR
	DN 12.5	10 525 4902	NBR
	DN 20	10 525 4903	NBR
	DN 25	10 525 4904	NBR
Dust caps	DN 6.3	09 525 1001	For couplings
		09 525 1051	For nipples
	DN 10	09 525 1002	For couplings
		09 525 1052	For nipples
	DN 12.5	09 525 1003	For couplings
		09 525 1053	For nipples
	DN 20	09 525 1004	For couplings
		09 525 1054	For nipples
	DN 25	09 525 1005	For couplings
		09 525 1055	For nipples

CEJN reserves the right to make changes without further notification. Check with an authorized CEJN distributor for availability and prices. All measurements are in mm. Thread connections are listed according to ISO Standards. Please visit our website, [www.cejn.com](http://www.cejn.com), for general maintenance tips.





# Nordic Range / 526 - Stainless steel High Performance Poppet Type Couplings

DN 6.3 (1/4"), DN10 (3/8"), DN 12.5 (1/2"), DN 20 (3/4"), DN 25 (1")

- Double sealing feature - no spray at connection
- Extra security locking ring
- All metal components made of AISI 316 stainless steel

Temperature range: ..... -20°C – +205°C (-4°F – +401°F)

Material seal:..... FPM

Material: ..... Stainless steel, AISI 316

Connectability: ..... Without pressure

Disconnection under pressure: ..... Not allowed



Body Size			Flow rate @ ΔP = 3 Bar		Max. working pressure***				Min. burst pressure			
ISO - DN	Inch	Dash	(l/min)**	(GPM)**	Connected		Disconnected		Connected		Disconnected	
					(bar)	(PSI)	(bar)	(PSI)	(bar)	(PSI)	(bar)	(PSI)
6.3	1/4"	-04	24	6.3	250	3625	250	3625	1000	14503	1000	14503
10	3/8"	-06	53	14.0	300	4351	250	3625	1200	17404	1000	14503
12.5	1/2"	-08	108	28.5	300	4351	250	3625	1200	17404	1000	14503
20	3/4"	-12	214	56.5	200	2900	200	2900	1000	14503	800	11603
25	1"	-16	322	85.1	200	2900	150	2175	800	11603	600	8702

(\*\*) If the application is constantly above this flow rate for the respective coupling size, a larger coupling size should be considered to avoid too high a pressure drop. The couplings can handle a much higher flow rate during short time periods, but there is a risk of heat build-up in the system. In general, surge flows above the normal flow rate are not a problem. (\*\*\*) In higher impulse applications only 50% of max. working pressure is recommended.

## COUPLINGS & NIPPLES

Size Nominal flow diameter			Seal	Connection			Part No.		Weight (g)		Package Qty.	
ISO	Inch	Dash		Description	Type	Standards	Coupling/Female	Nipple/Male	Coupling	Nipple	Coupling	Nipple
6.3	1/4"	-04	FPM	G 1/4"	Female thread	ISO 228/1	10 526 1212	10 526 6212	150	82	10	10
10	3/8"	-06		G 3/8"	Female thread	ISO 228/1	10 526 1214	10 526 6214	230	59	10	10
12.5	1/2"	-08		G 1/2"	Female thread	ISO 228/1	10 526 1215	10 526 6215	348	100	10	10
20	3/4"	-12		G 3/4"	Female thread	ISO 228/1	10 526 1217	10 526 6217	607	198	10	10
25	1"	-16		G 1"	Female thread	ISO 228/1	10 526 1219	10 526 6219	1020	368	5	5

## PRESSURE DROP CHART

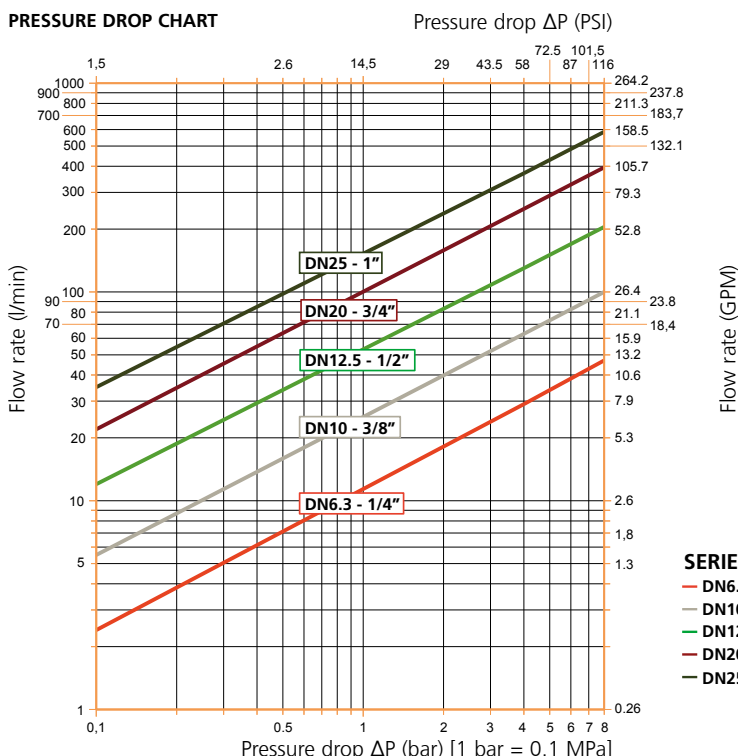

- SERIES**
- DN6.3 - 1/4"
  - DN10 - 3/8"
  - DN12.5 - 1/2"
  - DN20 - 3/4"
  - DN25 - 1"



CEJN reserves the right to make changes without further notification. Check with an authorized CEJN distributor for availability and prices. All measurements are in mm. Thread connections are listed according to ISO Standards. Please visit our website, [www.cejn.com](http://www.cejn.com), for general maintenance tips.



# Test-Point Systems

**Snap-Check** - *The quick connect pressure testing system*

**Press-Check** - *The ISO15171-2 screw to connect pressure testing system*

## SNAP-CHECK MONITORING SYSTEM

The quick connect monitoring system identifies your operating pressure without the need for a permanently installed gauge. The thermoplastic, high pressure hose enables you to monitor pressures from remote locations and connect gauges in the most confined areas. Applications include mobile equipment, injection molding machines, oil and gas equipment, marine vessels and production machinery. With a maximum working pressure of up to 600 bar (8700 PSI) Series 358 offer you products with extra-long and leak-free service, in addition it gives you unsurpassed reliability. The Snap-Check test point can quickly and easily be connected with the machine running with pressure up to 300 bar (4350 PSI). In the Snap-Check range you have test point nipples and couplings, mini-hose and gauges.

## PRESS-CHECK SERIES

The most common test point system in the world is test points according to ISO15171-2, which is a screw to connect type. The CEJN range, Series 359, consists of test points, mini hose and couplings for monitoring and testing of circuits in mobile and hydraulic equipment for working pressures up to 630 bar (9135 PSI). Press-Check offers a simple and inexpensive way to check the pressure in your hydraulic system and with CEJN's wide range of products you can always find the solution that fits your needs.





QR code for Snap-Check Monitoring System

# Snap-Check / 358 - Quick Connect Pressure Testing

- Connect under pressure up to 300 bar
- Compact design
- High working pressure
- One-hand operated
- Dust caps included as standard



Nominal flow diameter ..... 1.5 mm (1/16")  
 Connection under pressure ..... 300 bar (4350 PSI)  
 Max. working pressure connected ..... 600 bar (8700 PSI)  
 Min. burst pressure connected ..... 1300 bar (18860 PSI)  
 Min. burst pressure disconnected ..... 2400 bar (34810 PSI)  
 Temperature range ..... -30°C – +100°C (-22°F – +212°F)

## SNAP-CHECK TEST-POINT NIPPLES

Size Nominal flow diameter		Description	Connection		Part No. Nipple/Male	External Dimensions (mm)		
mm	Inch		Type	Standards		DN	Ln	HEXn
1.5	1/16"	R 1/8"	Male thread	ISO 7/1	10 358 6151	49.7	19.6	17
		R 1/4"	Male thread	ISO 7/1	10 358 6152	53.8	19.6	17
		R 3/8"	Male thread	ISO 7/1	10 358 6154	53.8	19.6	17
		G 1/8"	Male thread	ISO 228/1	10 358 6251	51.8	19.6	17
		G 1/4"	Male thread	ISO 228/1	10 358 6282	53.7	21.9	19
		G 3/8"	Male thread	ISO 228/1	10 358 6254	53.8	27.7	24
		1/8" NPT	Male thread	ANSI B1.20.1	10 358 6451	48.8	19.6	17
		1/4" NPT	Male thread		10 358 6452	52.7	19.6	17
		3/8" NPT	Male thread	ANSI B1.20.1	10 358 6454	52.7	19.6	17
		M10x1.25	Male thread	-	10 358 6551	50.8	19.6	17
		M12x1.5	Male thread	-	10 358 6552	53.8	19.6	17
		M14x1.5	Male thread	-	10 358 6554	53.7	23.1	20
		7/16" - 20 UNF	Male thread	-	10 358 6752	54.8	19.6	17
		7/8" - 14 UNF	Male thread	-	10 358 6755	55.3	34.6	30

## SNAP-CHECK NIPPLES SPECIFICALLY FOR NITROGEN GAS APPLICATIONS

Size Nominal flow diameter		Description	Connection		Part No. Nipple/Male	External Dimensions (mm)		
mm	Inch		Type	Standards		DN	Ln	HEXn
		G 1/4"	Male thread		10 358 6287	53.7	21.9	19

## SNAP-CHECK COUPLINGS

Size Nominal flow diameter		Description	Connection		Part No. Nipple/Male	External Dimensions (mm)		
mm	Inch		Type	Standards		DN	Ln	HEXn
1.5	1/16"	G 1/4"	Female thread	ISO 228/1	10 358 0202	46.8	23.4	20
		1/4" NPT	Female thread	ANSI B1.20.1	10 358 0402	46.3	23.4	20
		G 1/4"	Female thread 90°	ISO 228/1	10 358 0232	56.3	23.4	22
		1/4" NPT	Female thread 90°	ANSI B1.20.1	10 358 0432	56.3	23.4	22

## Hose

Extremely flexible, thermoplastic, high-pressure hose assemblies enable users to monitor pressures from remote locations and easily connect gauges in confined areas.

**Nominal flow diameter** ..... 2.0 mm (5/64")  
**Max. working pressure**..... 60.0 MPa  
**Min. burst pressure**..... 130.0 MPa  
**Temperature range** ..... -30°C – +100°C (-22°F – +212°F)



		Part No.	Connection 1	Connection 2	Length
Hose	Including adapters Male - Female	19 356 0021	G 1/4"	G 1/4"	850
		19 356 0041	G 1/4"	G 1/4"	1650
		19 356 0061	G 1/4"	G 1/4"	2500
		19 356 0081	G 1/4"	G 1/4"	4000

## Pressure Gauges

The pressure gauges of the Snap-Check system are encased in stainless steel AISI 304 and filled with glycerin. The Snap-Check standard range features a combined bar/PSI scale within an accuracy of ±1.6 percent of full scale.

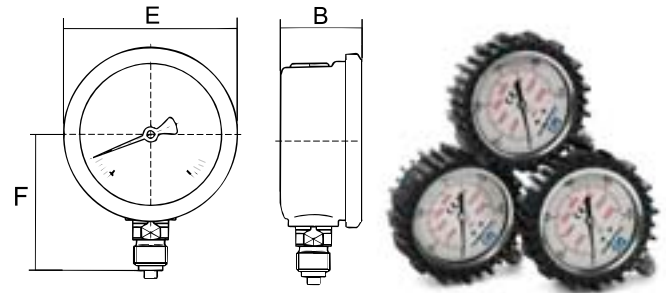

		Part No.	Connection	B	E	F	Pressure range
Ø 63 mm	Bottom connection Male thread	19 356 0102	G 1/4"	-	-	-	0–25 bar (0–362 PSI)
		19 356 0107	G 1/4"	32	68	54	0–60 bar (0–870 PSI)
		19 356 0108	G 1/4"	-	-	-	0–100 bar (0–1450 PSI)
		19 356 0126	G 1/4"	32	68	54	0–250 bar (0–3625 PSI)
		19 356 0141	G 1/4"	32	68	54	0–400 bar (0–5801 PSI)
		19 356 0146	G 1/4"	32	68	54	0–600 bar (0–8702 PSI)
		19 940 2120	G 1/4"	28	68	55.3	0–1000 bar (0–14503 PSI)

## Accessories

Available as Snap-Check accessories: a protective rubber cover that fits all Snap-Check Gauges, screw-on metal dust caps with wire straps that fit all standard nipples, copper seals to ensure leak-free gauge connections, rubber/metal seals for parallel male threaded nipples, and a durable carrying case.



		Part No.	Connection	Description
Rubber metal seal	Tredo	19 950 0061	G 1/8"	For 1/8" parallel male thread (tredo/dowty)
		19 950 0062	G 1/4"	For 1/4" parallel male thread (tredo/dowty)
		19 950 0064	G 3/8"	For 3/8" parallel male thread (tredo/dowty)
Copper seal	-	19 356 0210	-	Copper seal ensures leak-free gauge connections
Protective rubber cover	-	19 942 2500	-	Blue rubber cover, fits all gauges
Case	-	19 356 0292	-	Carrying case without components. Measurements 375 x 270 mm.



QR code for Press-Check Monitoring System

# Press-Check Monitoring System

- The ISO15171-2 screw to connect pressure testing system

- The most common test point system in the world is test points according to ISO15171-2
- Test points, mini hose and couplings for monitoring and testing of circuits in mobile and hydraulic equipment
- For working pressures up to 630 bar (9137 PSI)
- Offers a simple and inexpensive way to check the pressure in your hydraulic system



## Nipples

The test point nipples for the Press-Check system are available with plastic or metal dust caps and comes in four different sealing types; metal to metal seal, sealing by fitted ring, sealing by thread and sealing by O-ring.

- Material nipple..... Zinc-plated steel
- Material seal..... Nitrile (NBR)
- Temperature range ..... -20°C – +100°C (-4°F – +212°F)

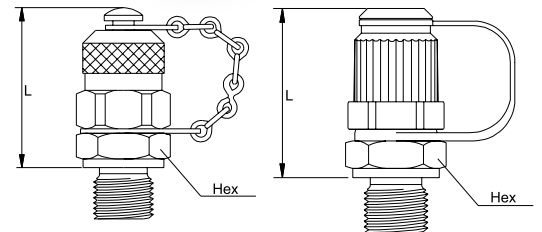

Seal	Connection Description	Part No.		External Dimensions (mm)		Max. working pressure (bar)
		With Plastic Cap	with Metal Cap	Ln	HEXn	
Sealing Type: Metal to Metal	M12x1.5 Male	10 359 1500	10 359 1550	38	17	400
	G 1/8" Male	10 359 1200	10 359 1250	38	17	
	G 1/4" Male	10 359 1201	10 359 1251	38	19	
Sealing Type: By Thread	UNI 7707 M10x1 Male	10 359 1502	10 359 1552	38	17	630
	R 1/8" Male	10 359 1100	10 359 1150	36	17	
	R 1/4" Male	10 359 1101	10 359 1151	36	17	
	R 3/8" Male	10 359 1102	10 359 1152	36	22	400
	1/8"-27 NPTF Male	10 359 1300	10 359 1350	36	17	
	1/4"-18 NPTF Male	10 359 1301	10 359 1351	36	17	
	3/8"-18 NPTF Male	10 359 1302	10 359 1352	36	22	
Sealing Type: by eolastic ring	M10x1 Male	10 359 1503	10 359 1553	38	17	630
	M12x1.5 Male	10 359 1504	10 359 1554	38	17	
	M14x1.5 Male	10 359 1505	10 359 1555	38	19	
	G 1/8" Male	10 359 1202	10 359 1252	38	17	400
	G 1/4" Male	10 359 1203	10 359 1253	38	19	
	G 3/8" Male	10 359 1204	10 359 1254	38	22	
Sealing Type: By O-ring	M8x1 Male	10 359 1507	10 359 1557	38	17	250
	M10x1 Male	10 359 1508	10 359 1558	38	17	
	M14x1.5 Male	10 359 1509	10 359 1559	38	19	
	7/16"-20 UNF Male	10 359 1700	10 359 1750	38	17	630
	1/2"-20 UNF Male	10 359 1701	10 359 1751	38	17	
	9/16"-18 UNF Male	10 359 1702	10 359 1752	38	19	
	3/4"-16 UNF Male	10 359 1703	10 359 1753	38	22	
	G 1/4" Male	10 359 1205	10 359 1255	38	19	

## Nipples 24° Sealing Cone

Test point nipples with 24° sealing cone are available in light and heavy designs according to DIN 3865. They come equipped with plastic or metal dust caps.

**Material nipple**..... Zinc-plated steel  
**Material seal**..... Nitrile (NBR)  
**Temperature range** ..... -20°C – +100°C (-4°F – +212°F)

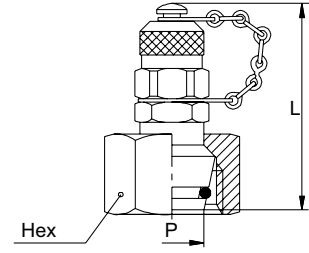

Size	Connection Description	Part No.		External Dimensions (mm)		Max. working pressure (bar)
		With Plastic Cap	with Metal Cap	Ln	HEXn	
L06	M12x1.5 Fem	10 359 1510	10 359 1560	65	14	315
L08	M14x1.5 Fem	10 359 1511	10 359 1561	66.5	17	
L10	M16x1.5 Fem	10 359 1512	10 359 1562	67	19	
L12	M18x1.5 Fem	10 359 1513	10 359 1563	58	22	
S06	M14x1.5 Fem	10 359 1514	10 359 1564	65	17	630
S08	M16x1.5 Fem	10 359 1515	10 359 1565	66.5	19	
S10	M18x1.5 Fem	10 359 1516	10 359 1566	67	22	
S12	M20x1.5 Fem	10 359 1517	10 359 1567	58	24	

## Nipples with T-Connection

Test point nipples with T-connections are available in light and heavy designs according to DIN 2353. They come equipped with plastic or metal dust caps.

**Material nipple**..... Zinc-plated steel  
**Material seal**..... Nitrile (NBR)  
**Temperature range** ..... -20°C – +100°C (-4°F – +212°F)

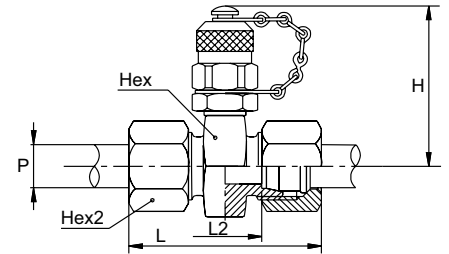

Seal	Connection Description	Part No.		External Dimensions (mm)		Max. working pressure (bar)
		With Plastic Cap	with Metal Cap	Ln	HEXn	
DIN 2353 Light	M12x1.5	10 359 1518	10 359 1568	54	19	315
	M14x1.5	10 359 1519	10 359 1569	54	24	
	M16x1.5	10 359 1520	10 359 1570	59	22	
	M18x1.5	10 359 1521	10 359 1571	59	24	
DIN 2353 Heavy	M14x1.5	10 359 1522	10 359 1572	58	19	630
	M16x1.5	10 359 1523	10 359 1573	59	22	
	M18x1.5	10 359 1524	10 359 1574	63	22	
	M20x1.5	10 359 1525	10 359 1575	63	22	

## Nipples with Female Swivel JIC 37° - SAE J514

Test point nipples with female swivel JIC 37° - SAE J514 design come equipped with plastic or metal dust caps.

**Material nipple**..... Zinc-plated steel  
**Material seal**..... Nitrile (NBR)  
**Temperature range** ..... -20°C – +100°C (-4°F – +212°F)

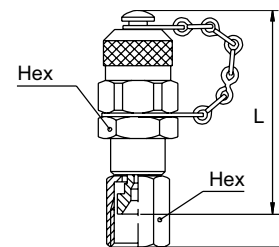

Size	Connection Description	Part No.		External Dimensions (mm)		Max. working pressure (bar)
		With Plastic Cap	with Metal Cap	Ln	HEXn	
JIC 37° - SAE J514	7/16"-20 UNF Fem	10 359 1704	10 359 1754	64	14	450
	1/2"-20 UNF Fem	10 359 1705	10 359 1755	67	17	420
	9/16"-18 UNF Fem	10 359 1706	10 359 1756	69	19	350
	3/4"-16 UNF Fem	10 359 1707	10 359 1757	71	22	

## Nipples with Female Swivel

Test point nipples with female swivel come equipped with plastic or metal dust caps.

**Material nipple**..... Zinc-plated steel  
**Material seal**..... Nitrile (NBR)  
**Temperature range** ..... -20°C – +100°C (-4°F – +212°F)

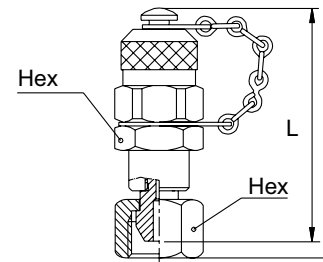

Size	Connection Description	Part No.		External Dimensions (mm)		Max. working pressure (bar)
		With Plastic Cap	with Metal Cap	Ln	HEXn	
G-Thread	G 1/4' Fem	10 359 1206	10 359 1256	62	19	630

## Nipples with Bulkhead Connections

Test point nipples with bulkhead connections with a metric thread. They come equipped with plastic or metal dust caps.

**Material nipple**..... Zinc-plated steel  
**Material seal**..... Nitrile (NBR)  
**Temperature range** ..... -20°C – +100°C (-4°F – +212°F)

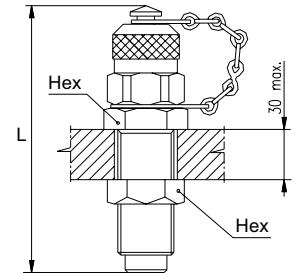

Size	Connection Description	Part No.		External Dimensions (mm)		Max. working pressure (bar)
		With Plastic Cap	with Metal Cap	Ln	HEXn	
Bulkhead	M16x2 Male	10 359 1611	10 359 1651	81	19	630

## Nipples with Bulkhead Connections acc. DIN 386

Test point nipples with bulkhead connections according to DIN 386. They come equipped with plastic or metal dust caps.

**Material nipple**..... Zinc-plated steel  
**Material seal**..... Nitrile (NBR)  
**Temperature range** ..... -20°C – +100°C (-4°F – +212°F)

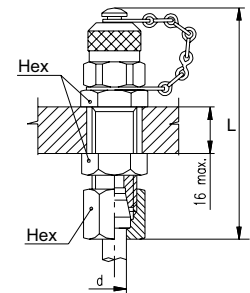

Size	Connection Description	Part No.		External Dimensions (mm)		Max. working pressure (bar)
		With Plastic Cap	with Metal Cap	Ln	HEXn	
Bulkhead Acc. DIN 386	M16x1.5	10 359 1527	10 359 1577	82	19	630
	M18x1.5	10 359 1528	10 359 1578	84	22	
bulkhead Acc. SAE J514	7/16"-20 JIC37° Male	10 359 1708	10 359 1758	68	17	450

## Stand Pipe Nipples

Stand pipe test point nipples come equipped with plastic or metal dust caps.

**Material nipple**..... Zinc-plated steel  
**Material seal**..... Nitrile (NBR)  
**Temperature range** ..... -20°C – +100°C (-4°F – +212°F)

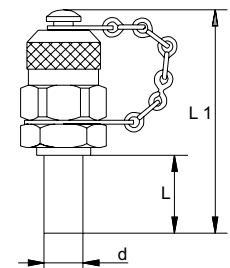

Size	Connection Description	Part No.		External Dimensions (mm)		Max. working pressure (bar)
		With Plastic Cap	with Metal Cap	Ln	HEXn	
Stand Pipe Ø6 mm	Ø6	10 359 1800	10 359 1850	57	20	630
Stand Pipe Ø8 mm	Ø8	10 359 1801	10 359 1851	57	20	

## Gauge connections

There are three designs for pressure gauge connections within the Press-Check range: bulkhead pressure gauge connection (fig.1), pressure gauge coupling (fig.2) and 90° pressure gauge swivel connection (fig.3). The pressure gauge coupling is available in two versions, one free flow and one with pressure damper.

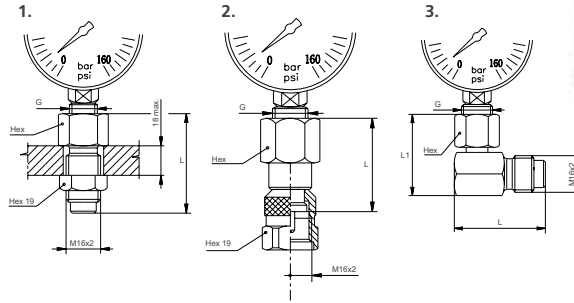

**Material nipple**..... Zinc-plated steel  
**Material seal**..... Nitrile (NBR)  
**Temperature range** ..... -20°C – +100°C (-4°F – +212°F)

		Part No.	Connection	Length	Length 2	Hexagon	Max working pressure
Free Flow	Bulkhead Connection	19 359 1600	G 1/4"	50	-	19	630 bar
		19 359 1601	G 1/2"	58	-	27	630 bar
		19 359 1602	1/4" NPTF	50	-	19	630 bar
	Coupling	19 359 1603	G 1/4"	34	-	19	630 bar
		19 359 1604	G 1/2"	39	-	27	630 bar
		19 359 1605	1/4" NPTF	34	-	19	630 bar
Swivel Connection	19 359 1606	G 1/4"	40	40	17	630 bar	
	19 359 1607	G 1/2"	43	40	27	630 bar	
	19 359 1608	G 1/4"	34	-	19	630 bar	
With Pressure Damper	Coupling	19 359 1609	G 1/2"	39	-	27	630 bar
		19 359 1610	1/4" NPTF	34	-	19	630 bar

## Coupling with 90° Elbow Connection

This coupling with 90° elbow connection is available as an accessory in the Press-Check range.

**Material nipple**..... Zinc-plated steel  
**Material seal**..... Nitrile (NBR)  
**Temperature range** ..... -20°C – +100°C (-4°F – +212°F)

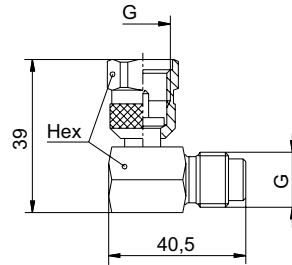

		Part No.	Connection	Length	Length 2	Hexagon	Max working pressure
Coupling	Elbow Connection	19 359 1613	M 16x2	39	40.5	19	630 bar

## Pressure Gauges

The pressure gauges of the Press-Check system are encased in stainless steel AISI 304 and filled with glycerin. The Snap-Check standard range features a combined bar/PSI scale within an accuracy of ±1.6 percent of full scale.

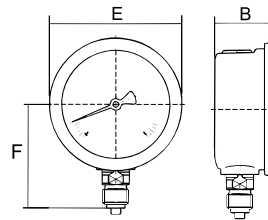

		Part No.	Connection	B	E	F	Pressure range
Ø 63 mm	Bottom connection Male thread	19 356 0102	G 1/4"	-	-	-	0–25 bar (0–362 PSI)
		19 356 0107	G 1/4"	32	68	54	0–60 bar (0–870 PSI)
		19 356 0108	G 1/4"	-	-	-	0–100 bar (0–1450 PSI)
		19 356 0126	G 1/4"	32	68	54	0–250 bar (0–3625 PSI)
		19 356 0141	G 1/4"	32	68	54	0–400 bar (0–5801 PSI)
		19 356 0146	G 1/4"	32	68	54	0–600 bar (0–8702 PSI)
	19 940 2120	G 1/4"	28	68	55.3	0–1000 bar (0–14503 PSI)	



## Accessories

Available as Press-Check accessories are: a protective rubber cover that fits all Press-Check Gauges, metal dust caps with wire straps and plastic dust caps that fit all Press-Check nipples.



		Part No.	Connection	Description
Plastic dust cap	-	19 359 4100	-	Fits all Press-Check nipples
Metal dust cap	-	19 359 4150	-	Fits all Press-Check nipples
Protective rubber cover	-	19 942 2500	-	Blue rubber cover, fits all gauges

## Hose DN2

- Flexible polyamide hose
- Working pressure up to 630 bar
- Large range of fittings



Extremely flexible, polyamide, high-pressure hose assemblies enable users to monitor pressures from remote locations and easily connect gauges in confined areas. Included in the hose range is also a wide range of fittings.

**ID x OD** ..... 2x5 mm  
**Min. bend radius**..... 20 mm  
**Max. working pressure**..... 630 bar  
**Test Pressure**..... 630 bar  
**Min. burst pressure**..... 1900 bar

**Design** ..... Tube and cover in polyamide with a kevlar braid  
**Weight** ..... 18 g/m  
**Temperature range** ..... -40°C – +100°C (-40°F – +212°F)  
**Comment** ..... 100% Working pressure between -20° to +50°C

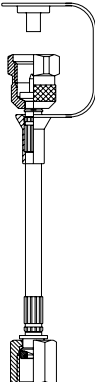
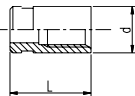
		Part No.	Connection	Length	Hexagon	Pipe dia.	Max working pressure connected
Hose	DN2	19 359 6400	-	-	-	-	630 bar
							
Sleeve	Ø8 mm	19 359 6420	Ø8	14	-	-	- bar
							
Couplings for test nipple	Nut connection	19 359 6458	M 16x1.5	22	19	-	630 bar
		19 359 6430	M 16x2	22	19	-	630 bar
Female swivels	DIN 3865	19 359 6432	M 14x1.5	21	17	6	630 bar
		19 359 6433	M 14x1.5	21	17	8	315 bar
		19 359 6434	M 16x1.5	21	19	8	630 bar
		19 359 6435	M 16x1.5	21	19	10	315 bar
		19 359 6436	M 18x1.5	21	22	10	630 bar
	DIN 3865 90° Elbow	19 359 6437	M 12x1.5	27	14	6	315 bar
		19 359 6438	M 14x1.5	27	17	6	630 bar
		19 359 6439	M 14x1.5	27	17	8	315 bar
		19 359 6440	M 16x1.5	27	19	8	630 bar
		19 359 6441	M 16x1.5	27	19	10	315 bar
19 359 6442	M 18x1.5	27	22	10	630 bar		

CEJN reserves the right to make changes without further notification. Check with an authorized CEJN distributor for availability and prices. All measurements are in mm. Thread connections are listed according to ISO Standards. Please visit our website, [www.cejn.com](http://www.cejn.com), for general maintenance tips.

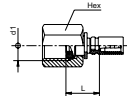
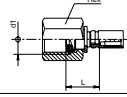
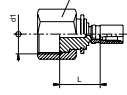
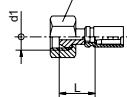
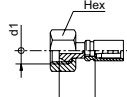
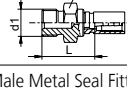
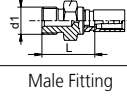
		Part No.	Connection	Length	Hexagon	Pipe dia.	Max working pressure connected
Gauge adapters	Female Pressure Gauge Adapter EN 837-1	19 359 6443	G 1/4"	15	17	-	630 bar
		19 359 6444	G 1/2"	17	27	-	630 bar
	Female Pressure Gauge Adapter	19 359 6445	M 20x1.5	17	24	-	630 bar
		19 359 6446	1/4" -18 NPTF	23	19	-	630 bar
Female swivels	Female Swivel ISO 8434-3	19 359 6447	11/16" -16UNF	23	19	-	630 bar
		19 359 6448	G 1/8"	14	14	-	630 bar
	60° Female Swivel DIN 3863	19 359 6449	G 1/4"	18	17	-	630 bar
		19 359 6450	7/16" -20 UNF	15	14	-	450 bar
	JIC 37° Female Swivel	19 359 6451	1/2" -20 UNF	17	16	-	420 bar
		19 359 6452	G 1/8"	19	13	-	400 bar
Male fittings	Male Metal Seal Fitting	19 359 6453	G 1/4"	24.5	19	-	630 bar
		19 359 6454	1/8" -27 NPTF	21	13	-	400 bar
	Male Fitting	19 359 6455	Ø4	26	-	-	- bar
Stand pipe	Stand Pipe	19 359 6456	Ø6	25	-	-	- bar
		19 359 6457	Ø8	25	-	-	- bar
	Stand Pipe						

CEJN reserves the right to make changes without further notification. Check with an authorized CEJN distributor for availability and prices. All measurements are in mm. Thread connections are listed according to ISO Standards. Please visit our website, [www.cejn.com](http://www.cejn.com), for general maintenance tips.

## Hose DN4

- Flexible polyamide hose
- Working pressure up to 630 bar
- Large range of fittings

Extremely flexible, polyamide, high-pressure hose assemblies enable users to monitor pressures from remote locations and easily connect gauges in confined areas. Included in the hose range is also a wide range of fittings.



**ID x OD** ..... 4x8 mm  
**Min. bend radius**..... 40 mm  
**Max. working pressure**..... 500 bar  
**Test Pressure**..... 500 bar  
**Min. burst pressure**..... 1500 bar

**Design**..... Tube and cover in polyamide with a kevlar braid  
**Weight** ..... 47 g/m  
**Temperature range** ..... -40°C – +100°C (-40°F – +212°F)  
**Comment** ..... 86% working pressure above +80°C

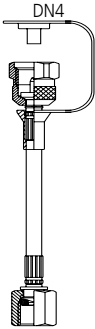
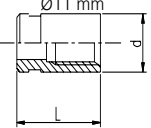
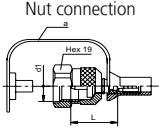
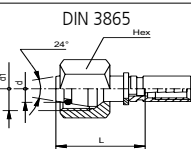
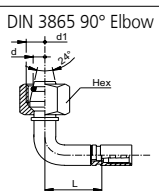
		Part No.	Connection	Length	Hexagon	Pipe dia.	Max working pressure connected
Hose		19 359 6700	-	-	-	-	500 bar
Sleeve		19 359 6720	Ø11	21	-	-	- bar
Couplings for test nipple		19 359 6730	M 16x2	24	19	-	500 bar
Female Swivels		19 359 6732	M 14x1.5	21	17	6	500 bar
		19 359 6733	M 14x1.5	21	17	8	315 bar
		19 359 6734	M 16x1.5	21	19	8	500 bar
		19 359 6735	M 16x1.5	21	19	10	315 bar
		19 359 6736	M 18x1.5	21	22	10	500 bar
		19 359 6737	M 12x1.5	27	14	6	315 bar
		19 359 6738	M 14x1.5	27	17	6	500 bar
		19 359 6739	M 14x1.5	27	17	8	315 bar
		19 359 6740	M 16x1.5	27	19	8	500 bar
		19 359 6741	M 16x1.5	27	19	10	315 bar
		19 359 6742	M 18x1.5	27	22	10	500 bar



**CEJN**® *The Quick Connect*  
**Solution Provider**

